

# LAB.GRUPPEN

**COMPACT**

**VERSATILE**

**COST-EFFECTIVE**

**450–2100 W**

*Latest semiconductor technology and copper cooling system.*

**You are a Sound Specialist.**

**So are our iP Series power amplifiers.**

You need reliable amp technology, plus that special little extra for comfort and performance.

A perfect combination for perfectionists.



# Unconventionally Conventional.

You have to admit, these moments in life are rare: finding the perfect balance in between the exciting extraordinary and the comforting safety of what is common and well known since long. On one side we enjoy the unconventional elements that we can identify ourselves with individually, and that set us apart from that gray mass. On the other side we like to rely on well proven facts, especially if we and others depend on it.

From the initial start in the 1980's on and continuously, at Lab.gruppen we combine innovative and outstanding ideas with rock-solid technology. Our iP Series of professional power amplifiers

is one example. Here you will find unconventional designs and features from our leading flagship products paired with what we may call "conventional power supplies". The result is unique and exciting, indeed: iP Series power amplifiers are the cream of their class. Supreme performers. Quality symbols. Eternal work horses in any professional sound system.

Make yourself depending, and be dependable: no matter if you need natural sound reproduction in a critical theater situation, or if it is pure rock'n'roll in a

funky shed. iP Series amplifiers are as reliable and flexible as everything else from Lab.gruppen. With four 2-channel models and one 4-channel version we offer you a wide range of amplifiers for many possible applications. Although they are rather compact in their dimensions, they are anything but small: the iP 2100 can deliver more than 2,000 W!

As you keep reading you will find out all about the details. You will understand the grand tricks we hide behind the front panels that look so unsuspectingly neutral. And you will know that the iP

Series is the ultimate power engine and a solid investment for you, too.



Welcome to the unconventional family of Lab.gruppen users all across the world!

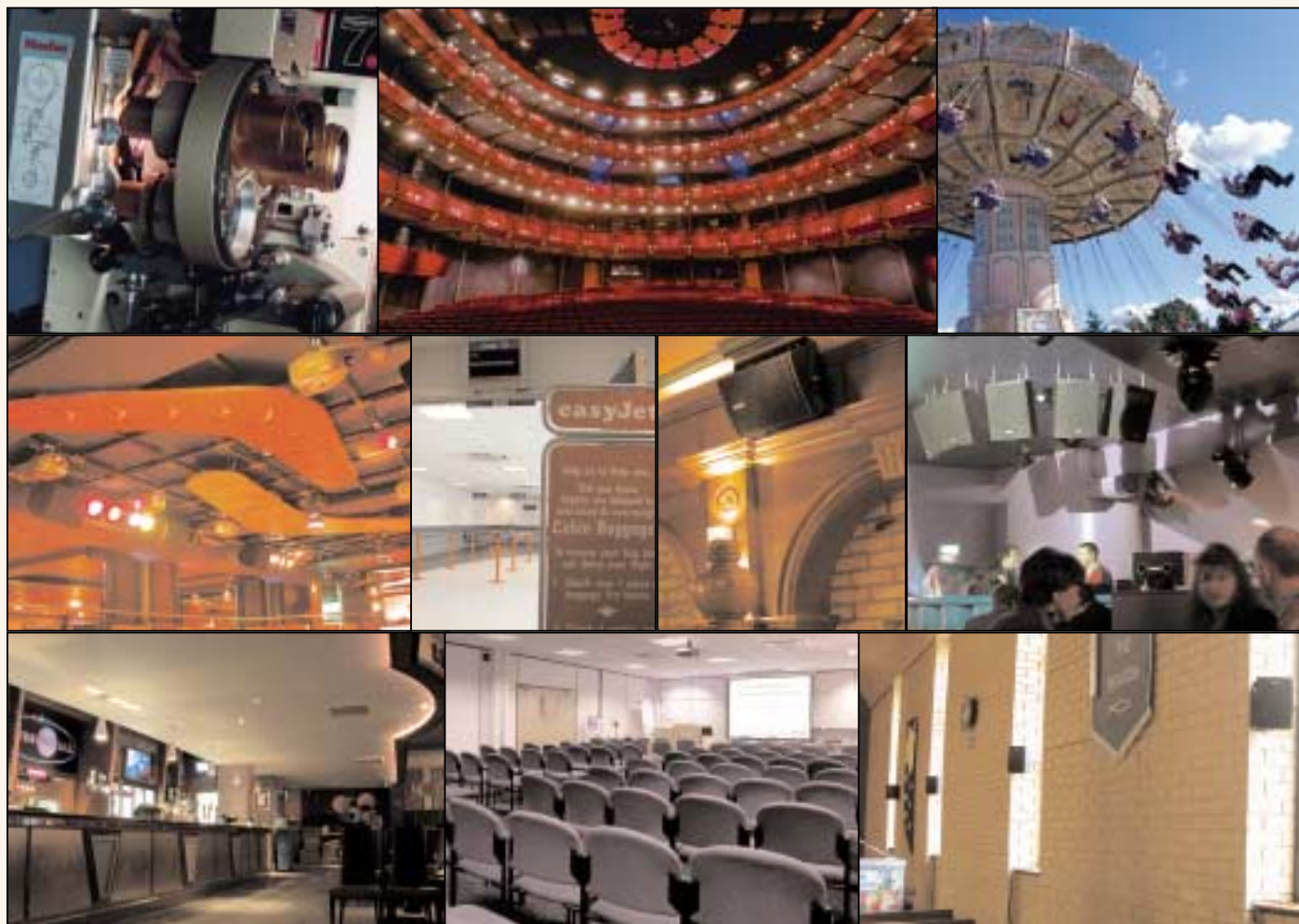

## Stay Cool.

“Amplifiers get hot.” Wrong! Because there is Lab.gruppen. Sure, heat is generally a problem because it stresses the components and has led elsewhere to shows ending early. Some amplifiers even go into protection by shutting down completely or by reducing the output power dramatically.

We have learned mastering the art of heat reduction inside power amplifiers while designing amps capable of providing more than 6,000 watts of output power. No doubt that the iP Series is well able to stay cool.

### SPEED-CONTROLLED FANS

iP Series amplifiers produce relatively little heat to start with. To get rid of it, we use speed-controlled fans\*. They move the cooling air from front to rear, because this makes the best sense. The air is directed into a compression chamber, and then guided through the heat sinks.

The cooling differs in three distinct ways to common schemes.

**Difference #1:** Our output transistors are located side-by-side in the airstream, all getting the same cool air at the same time. Not one of them gets hotter due to being positioned at the wrong end of a tunnel. We keep them all cool.

**Difference #2:** Our heat sinks offer plenty of surface area, again broken up into tiny little fins. Greater air turbulence = better cooling.

**Difference #3:** Our heat sinks are made out of copper. Its heat dissipation is many times better than aluminum.

### INTERCOOLER®

The result is an ultra-efficient and compact cooling system we call Intercooler®. What you get is an amplifier that stays cool, even if driven hard and for long periods of time. You may also stack as many as you want directly on top of each other without space in between.

**Pure physics and smart engineering. Cool!**

\* = The iP 450 is convection cooled. It has external heat sinks and operates without fans.



Removable dust filter on the front panel.

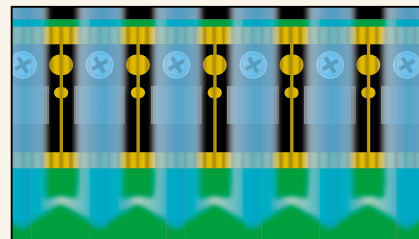

The parallel airflow through the Intercooler™.



Copper heat sinks with tiny fins.

## Current Capacity.

Wherever we talk electrical power, we talk voltage and current. Not only is the current as important as the voltage; in an audio amplifier the amount of available current is critical for the sonic performance. Needless to say that a professional power amplifier should be able to handle large current safely and properly in an ever changing environment, to work and sound well even with low impedances, and to provide a maximum of headroom for live sound dynamics.

Our iP Series has been designed to provide this amount of current, making these amplifiers truly professional products. Even in extreme situations, e.g. should you require them to drive  $2 \Omega$  loads and at high power levels, they keep playing. And thanks to they keep sounding as great as if they were just idling along. “HiFi performance at maximum output” – isn’t this what you expect? Then you have found it!

The iP Series features heavy-duty power supplies with massive toroidal transformers, able to support the output

signal in power and quality. Why would Lab.gruppen as pioneers of the R.SMPS technology\* put a classic power supply design into their amplifiers, you may ask yourself. Simply because at the output power range of the iP Series the conventional power supply remains to be an efficient and economic way of providing the necessary energy. As top model of the iP Series the iP 2100 with its maximum output power of more than 2,000 W comes in a compact 2 RU package size weighing only 18 kg (40 lbs).

Naturally, we were thinking our current philosophy to its end. So, while dealing with high current we simultaneously keep an eye on safety – for both, you and your equipment. Fulfilling the global standards of electrical safety is one way of getting there. The implementation of “Soft Start” circuitry protects the connected speakers at one end of the amplifiers from unwanted spikes and the mains breakers at another end from popping during the power-on routine.

**Keep the current flowing as high as your expectations. Use Lab.gruppen.**



The output transistors are located side-by-side in the airstream

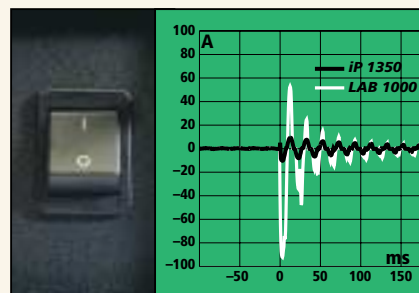

“Soft Start” protects speakers and mains fuse.

\* = R.SMPS stands for Lab.gruppen’s unique Regulated Switch Mode Power Supply as used e.g. in the fP Series, where it helps optimizing the power-to-weight ratio at greater output power levels.

# Gain Knowledge.

A professional amplifier should fit nicely into any sound system. The reality is that some fit better than others. Lab.gruppen amplifiers fit the best, and the iP Series is no different.

When playing together with other equipment the critical question is the gain structure of the system. There are various ways of dealing with it. The Lab.gruppen way is simple but also the most flexible. On the rear panel you will find the Multiple Position Gain Switch. Pick one out of eight gain settings between 20 dB and 41 dB. High gain = high input sensitivity, and vice versa. Eight steps to get to proper headroom. Eight chances to reduce the risk of clipped signals. Eight possibilities to enjoy the full output power of a Lab.gruppen amplifier. And eight great opportunities to adjust perfectly to the gain requirements of virtually any loudspeaker system controller! All available at the flip of a switch.

Lab.gruppen love to share their gained knowledge with you.

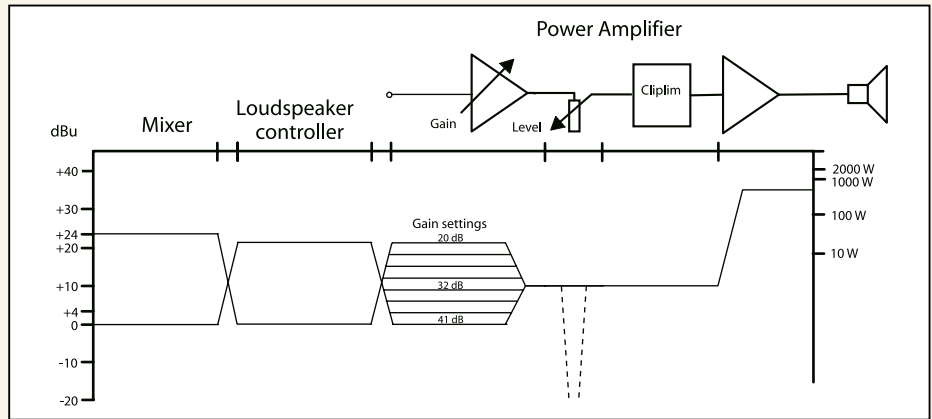
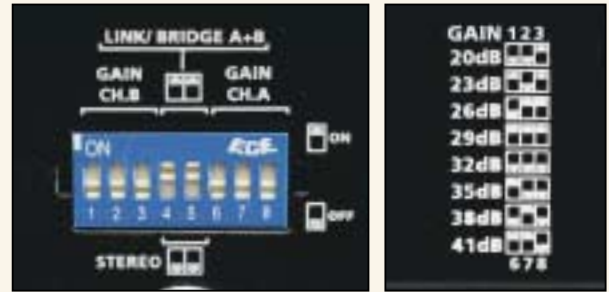

Gain structure.

# Not at all intriguing: In & Out.

The simple things get often overlooked. Why? We don't know. So, we decided to make it really simple for you to connect our amplifiers to the outside world.

Neutrik Combo® input connectors adapt to both worlds; XLR or 1/4" phone plugs. Either way, it is a balanced input.

Alternatively, Phoenix connectors can be used, making the iP Series adaptable to the widely accepted standards of permanently installed systems.

All output signals find their way out through Neutrik Speakon® connectors – safe, and a world standard. Of course, each channel has its own output connector, but to save you from hassling around with adaptors we have also made both channel outputs available on a single Speakon® (except iP 1150Q: four channels, two each into two Speakons®).

We have the proper connections. Please make use of them.



Neutrik Combo® input jacks adapt to both worlds, XLR or 1/4" phone plugs.

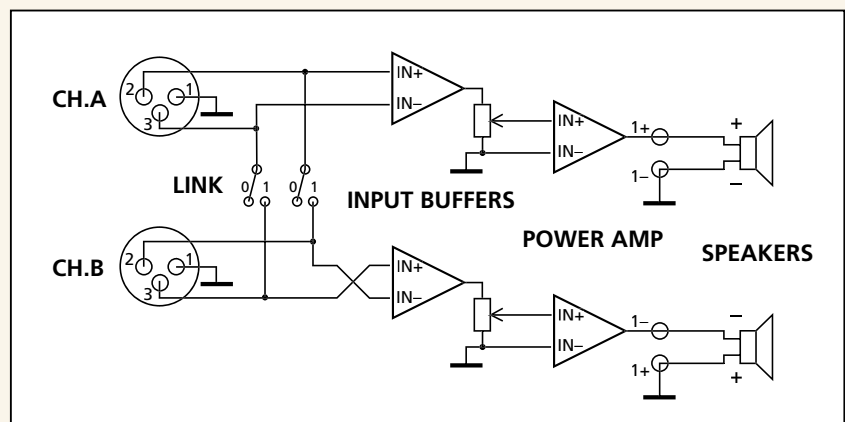

The simple scheme of In & Out.

## Protect Yourself?

When working with a Lab.gruppen iP Series amplifier, all necessary protection is already built in to prevent damage to your amp and as much as possible to your speakers as well. All protection circuitry has an automatic reset, so you do not need to worry, or take any action.

### THERMAL PROTECTION

Should you – against all odds – manage to overheat the amp, the Thermal Protection will mute the affected amp channel until it has cooled down.

### ALS®

Our smart ALS® is an 'Adaptive Limiting System' that monitors the output signal continuously to limit its current dynamically.

If for any reason distortion above 1 % THD appears between input and output of an amp channel, a Clip Limiter will reduce the signal proportionally. You only need to make sure that the input signal is 'clean'. The Clip Limiter is the only protection that you can manually defeat using recessed switches on the rear.

### VHF PROTECTION

To protect your HF drivers from any oscillation, the VHF Protection will mute the amp once a signal above 12 kHz is present at the amp's output at full output power for more than five seconds.

### AC MAINS VOLTAGE PROTECTION

iP Series amps have an extremely wide window of operation where mains voltage is concerned; however, in the case of the mains voltage being below or above the window of operation, the amplifier will mute itself thanks to its AC Mains Voltage Protection.

Naturally, all Lab.gruppen amps are DC and Short Circuit protected.

**Average life is risky enough. Audio is safe with Lab.gruppen.**



Recessed bypass switch per channel for the clip limiter.



Indicators for VHF and temperature protection.



High-frequency drivers are well protected by the automatic VHF-protection.



## We only make Amplifiers.

We do not make receivers or transmitters. From the early days that we were making Switch Mode amplifiers, we always complied with any emission

check elsewhere.

**You're not alone. When it comes to power amps, Lab.gruppen is on your side.**

and immunity requirements, including today's tough European Electro-Magnetic Compatibility directive (EMC).

With Lab.gruppen iP Series amplifiers you do not need to fear any interference with RF equipment. If you hear strange voices please

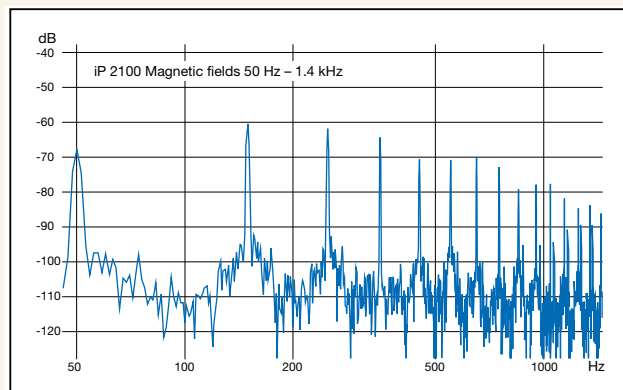

Lab.gruppen's EMC test facilities. 8,000 volts are being "shot" with this gun for testing!



The very finest test equipment is made in-house; here is a coil for measuring the hum field.

## iP 2100

Power specifications: stereo 8 ohms 4 ohms 2 ohms  
EIA at 1 kHz and 1% THD 425 W 700W 1050 W

- ◆ Intercooler®, speed-controlled fans
- ◆ Multiple Position Gain
- ◆ XLR & Phoenix input connector
- ◆ Soft start
- ◆ Weight: 18 kg (40 lbs)
- ◆ Dimensions: 2 RU x 325 mm (12.8")



## iP 1350

Power specifications: stereo 8 ohms 4 ohms 2 ohms  
EIA at 1 kHz and 1% THD 300 W 500 W 700 W

- ◆ Intercooler®, speed-controlled fans
- ◆ Multiple Position Gain
- ◆ XLR & Phoenix input connector
- ◆ Soft start
- ◆ Weight: 15 kg (33 lbs)
- ◆ Dimensions: 2 RU x 325 mm (12.8")



## iP 900

Power specifications: stereo 8 ohms 4 ohms 2 ohms  
EIA at 1 kHz and 1% THD 200 W 320 W 470 W

- ◆ Intercooler®, speed-controlled fans
- ◆ Multiple Position Gain
- ◆ XLR & Phoenix input connector
- ◆ Soft start
- ◆ Weight: 12.5 kg (27.5 lbs)
- ◆ Dimensions: 2 RU x 325 mm (12.8")



## iP 450

Power specifications: stereo 8 ohms 4 ohms 2 ohms  
EIA at 1 kHz and 1% THD 110 W 160 W 200 W

- ◆ Conventional cooling (no fan)
- ◆ Multiple Position Gain
- ◆ XLR & Phoenix input connector
- ◆ Weight: 7.5 kg (17 lbs)
- ◆ Dimensions: 1 RU x 280 mm (11")



## iP 1150Q

Power specifications: 4 ch. 8 ohms 4 ohms 2 ohms  
EIA at 1 kHz and 1% THD 130 W 200 W 270 W

- ◆ Intercooler®, speed-controlled fans
- ◆ Multiple Position Gain
- ◆ XLR & Phoenix input connector
- ◆ Soft start
- ◆ Weight: 13.2 kg (29 lbs)
- ◆ Dimensions: 2 RU x 325 mm (12.8")



# Technical Data.

	<b>iP2100</b>	<b>iP1350</b>	<b>iP900</b>	<b>iP450</b>	<b>iP1150Q</b> Four channels
<b>Max output power<sup>1)</sup></b> EIA at 1 kHz and 1 % THD					
8 Ω per channel	425 W	300 W	200 W	110 W	130 W
4 Ω per channel	700 W	500 W	320 W	160 W	200 W
2 Ω per channel	1050W	700 W	470 W	200 W	270 W
8 Ω bridged	1400 W	1000 W	600 W	300 W	400 W
4 Ω bridged	2100 W	1400 W	900 W	400 W	540 W
<b>Max output voltage</b>					
8 ohms load	58 V <sub>rms</sub>	49 V <sub>rms</sub>	39 V <sub>rms</sub>	30 V <sub>rms</sub>	32 V <sub>rms</sub>
Peak voltage, no load	92 V	77 V	63 V	50 V	51 V
<b>Distortion etc.</b>					
THD 20 Hz – 20 kHz and 1 W to full power	0.05 %	0.03 %	0.02 %	0.05 %	0.05 %
THD at 1 kHz and 1 dB below clipping	0.005 %	0.005 %	0.005 %	0.03 %	0.01 %
DIM 30 at 3 dB below clipping	0.005 %	0.005 %	0.008 %	0.02%	0.008 %
<b>Hum and noise</b>	< -105 dB	< -110 dB	< -105 dB	< -105 dB	< -105 dB
<b>Channel separation at 10 kHz</b>	70 dB	70 dB	70 dB	70 dB	70 dB
<b>Output impedance</b>	30 mΩ	30 mΩ	30 mΩ	30 mΩ	30 mΩ
Slew rate	45 V/μs	45 V/μs	30 V/μs	25 V/μs	30 V/μs
<b>Inputs</b>					
Gain selectable	20, 23, 26, 29, 32, 35, 38, 41	20, 23, 26, 29, 32, 35, 38, 41	20, 23, 26, 29, 32, 35, 38, 41	20, 23, 26, 29, 32, 35, 38, 41	32
Impedance	20 kΩ	20 kΩ	20 kΩ	20 kΩ	20 kΩ
Common mode rejection	50 dB	50 dB	50 dB	50 dB	50 dB
<b>Front panel</b>					
Gain controls	31 pos detent	31 pos detent	31 pos detent	31 pos detent	31 pos detent
Indicators per channel:					
Protect	Yes	Yes	Yes	Yes	Yes
Clip	Yes	Yes	Yes	Yes	Yes
Signal present	- 40 dB	- 40 dB	- 40 dB	- 25 dB	- 40 dB
<b>Rear panel</b>					
Input connectors	Neutrik Combo+	Neutrik Combo+	Neutrik Combo+	Neutrik Combo+	Neutrik Combo
Clip limiters	3 pin Phoenix On/Off, each ch.	3 pin Phoenix On/Off, each ch.	3 pin Phoenix On/Off, each ch.	3 pin Phoenix On/Off, each ch.	On/Off, each ch.
<b>Power</b>					
Operation voltage, 230V/115V	<u>130-260V/65-135V</u>	<u>130-260V/65-135V</u>	<u>130-260V/65-135V</u>	130-260V/65-135V	<u>130-260V/65-135V</u>
Soft Start	Yes	Yes	No	No	No
Peak inrush current	20 A	20 A	10 A	20 A	70 A
Full output power at 4 ohms, 230V/115V	230V/115V	230V/115V	230V/115V	230V/115V	230V/115V
Minimum start-up voltage, 230V/115V	<u>190V/95V</u>	<u>190V/95V</u>	180/95V	NA	180/95V
230 V or 115 V versions	Yes	Yes	Yes	Yes	Yes
<b>Current draw at 4 Ω and 230V/115V</b>					
Idle, no load at output	0.8 A <sub>rms</sub>	0.6 A <sub>rms</sub>	0.5 A <sub>rms</sub>	0.1 A <sub>rms</sub>	0.6 A <sub>rms</sub>
1/8 of full power (-9 dB)	5.2 A <sub>rms</sub>	3.5 A <sub>rms</sub>	2.3 A <sub>rms</sub>	0.8 A <sub>rms</sub>	2.9 A <sub>rms</sub>
1/3 of full power (-5 dB)	8.0 A <sub>rms</sub>	5.5 A <sub>rms</sub>	3.7 A <sub>rms</sub>	1.5 A <sub>rms</sub>	4.5 A <sub>rms</sub>
At full power (0 dB) at 1 kHz 1 % THD	13.0 A <sub>rms</sub>	9.4 A <sub>rms</sub>	6.5 A <sub>rms</sub>	3.3 A <sub>rms</sub>	7.9 A <sub>rms</sub>
<b>Dimensions</b>					
Width	483 mm (19")	483 mm (19")	483 mm (19")	483 mm (19")	483 mm (19")
Height	88 mm (3.5")	88 mm (3.5")	88 mm (3.5")	44 mm (1.75")	88 mm(3.5")
Depth	325 mm (12.8")	325 mm (12.8")	325 mm (12.8")	280 mm (11.0")	325 mm (12.8")
Weight	18.0 kg (39.6 lbs)	15.0 kg (33 lbs)	12.5 kg (27.5 lbs)	7.5 kg (17 lbs)	13.3 kg (29 lbs)

**Approvals: CE**

Emission: EN 55 103-1, E3

Immunity: EN 55 103-2, E3, with S/N below 1 % at normal operation level

Safety: EN 60 065, class 1, THX approval except iP 450

1) Specifications measured with 230 V AC

Lab.gruppen reserve the right to alter functions or the specifications without prior notice.

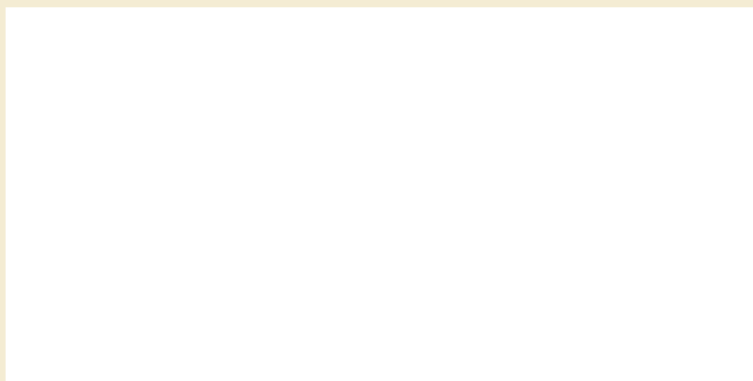

# LAB.GRUPPEN

Lab.gruppen AB, Gullregnsvägen 16, SE-434 44 Kungsbacka, Sweden  
Tel: +46 300 56 28 00 Fax: +46 300 56 28 99  
info@labgruppen.com www.labgruppen.com