

MACKIE®

ONYX® 80 Series

**PREMIUM LIVE ANALOG MIXERS
w/PERKINS EQ & ONYX MIC PREAMPS**

OWNER'S MANUAL

ONYX
ONYX
ONYX
ONYX
ONYX
ONYX
ONYX
ONYX
ONYX

Important Safety Instructions

1. Read these instructions.
2. Keep these instructions.
3. Heed all warnings.
4. Follow all instructions.
5. Do not use this apparatus near water.
6. Clean only with dry cloth.
7. Do not block any ventilation openings. Install in accordance with the manufacturer's instructions.
8. Do not install near any heat sources such as radiators, heat registers, stoves, or other apparatus (including amplifiers) that produce heat.
9. Do not defeat the safety purpose of the polarized or grounding-type plug. A polarized plug has two blades with one wider than the other. A grounding-type plug has two blades and a third grounding prong. The wide blade or the third prong are provided for your safety. If the provided plug does not fit into your outlet, consult an electrician for replacement of the obsolete outlet.
10. Protect the power cord from being walked on or pinched particularly at plugs, convenience receptacles, and the point where they exit from the apparatus.
11. Only use attachments/accessories specified by the manufacturer.
12. Use only with a cart, stand, tripod, bracket, or table specified by the manufacturer, or sold with the apparatus. When a cart is used, use caution when moving the cart/apparatus combination to avoid injury from tip-over.
13. Unplug this apparatus during lightning storms or when unused for long periods of time.
14. Refer all servicing to qualified service personnel. Servicing is required when the apparatus has been damaged in any way, such as power-supply cord or plug is damaged, liquid has been spilled or objects have fallen into the apparatus, the apparatus has been exposed to rain or moisture, does not operate normally, or has been dropped.
15. This Onyx mixer has been designed with Class-I construction and must be connected to a mains socket outlet with a protective earthing connection (the third grounding prong).
16. This Onyx mixer has been equipped with an all-pole, rocker-style AC mains power switch. This switch is located on the rear panel and should remain readily accessible to the user.
17. This apparatus does not exceed the Class A/Class B (whichever is applicable) limits for radio noise emissions from digital apparatus as set out in the radio interference regulations of the Canadian Department of Communications.

ATTENTION — *Le présent appareil numérique n'émet pas de bruits radioélectriques dépassant les limites applicables aux appareils numériques de class A/de class B (selon le cas) prescrites dans le règlement sur le brouillage radioélectrique édicté par les ministere des communications du Canada.*

18. Exposure to extremely high noise levels may cause permanent hearing loss. Individuals vary considerably in susceptibility to noise-induced hearing loss, but nearly everyone will lose some hearing if exposed to sufficiently intense noise for a period of time. The U.S. Government's Occupational Safety and Health Administration (OSHA) has specified the permissible noise level exposures shown in the following chart.

According to OSHA, any exposure in excess of these permissible limits could result in some hearing loss. To ensure against potentially dangerous exposure to high sound pressure levels, it is recommended that all persons exposed to equipment capable of producing high sound pressure levels use hearing protectors while the equipment is in operation. Ear plugs or protectors in the ear canals or over the ears must be worn when operating the equipment in order to prevent permanent hearing loss if exposure is in excess of the limits set forth here.

Duration Per Day In Hours	Sound Level dBA, Slow Response	Typical Example
8	90	Duo in small club
6	92	
4	95	Subway Train
3	97	
2	100	Very loud classical music
1.5	102	
1	105	Tami screaming at Adrian about deadlines
0.5	110	
0.25 or less	115	Loudest parts at a rock concert

PORTABLE CART WARNING



Carts and stands - The Component should be used only with a cart or stand that is recommended by the manufacturer. A Component and cart combination should be moved with care. Quick stops, excessive force, and uneven surfaces may cause the Component and cart combination to overturn.

CAUTION AVIS

RISK OF ELECTRIC SHOCK
DO NOT OPEN

RISQUE DE CHOC ELECTRIQUE
NE PAS OUVRIR

CAUTION: TO REDUCE THE RISK OF ELECTRIC SHOCK
DO NOT REMOVE COVER (OR BACK)
NO USER-SERVICEABLE PARTS INSIDE
REFER SERVICING TO QUALIFIED PERSONNEL

ATTENTION: POUR EVITER LES RISQUES DE CHOC
ELECTRIQUE, NE PAS ENLEVER LE COUVERCLE. AUCUN
ENTRETIEN DE PIECES INTERIEURES PAR L'USAGER. CONFIER
L'ENTRETIEN AU PERSONNEL QUALIFIE.

AVIS: POUR EVITER LES RISQUES D'INCENDIE OU
D'ELECTROCUTION, N'EXPOSEZ PAS CET ARTICLE
A LA PLUIE OU A L'HUMIDITE

The lightning flash with arrowhead symbol within an equilateral triangle is intended to alert the user to the presence of uninsulated "dangerous voltage" within the product's enclosure, that may be of sufficient magnitude to constitute a risk of electric shock to persons.

Le symbole clair avec point de flèche l'intérieur d'un triangle équilatéral est utilisé pour alerter l'utilisateur de la présence d'un risque de choc électrique.

The exclamation point within an equilateral triangle is intended to alert the user of the presence of important operating and maintenance (servicing) instructions in the literature accompanying the appliance.

Le point d'exclamation l'intérieur d'un triangle équilatéral est employé pour alerter les utilisateurs de la présence d'instructions importantes pour le fonctionnement et l'entretien (service) dans le livret d'instruction accompagnant l'appareil.

WARNING — To reduce the risk of fire or electric shock, do not expose this apparatus to rain or moisture.

Table of Contents

Introduction	4
Getting Started	5
Zero the Controls	5
Connections	5
Set the Levels	5
Instant Mixing	5
Hookup Diagrams	6
Onyx 80 Series Features	10
Channel Strips	10
Auxiliary Section	14
Group Section	16
Metering, Matrix, and Power LEDs.....	17
TALKBACK Section, MUTE GROUPS, and MONO OUT.....	19
MAIN MIX and PHONES/MONITOR Section	20
Rear Panel.....	21
Appendix A: Service Information	25
Warranty Service.....	25
Troubleshooting	25
Repair	26
Appendix B: Connections	27
Appendix C: Technical Info	30
Onyx 80 Series Specifications	30
Onyx 80 Series Dimensions.....	32
Onyx 80 Series Block Diagram	33
Onyx 80 Series Gain Structure Diagram.....	34
Onyx 80 Series Limited Warranty	35

Don't forget to visit our website at www.mackie.com for more information about this and other Mackie products.



Introduction

Thank you for choosing a Mackie Onyx 80 Series professional live mixing console. The Onyx 80 Series of mixers feature all-new analog circuitry and the latest technologies for live sound reinforcement in a durable, road-worthy package.

The Onyx 80 Series mixing consoles come in four sizes: the 24-channel Onyx 2480, 32-channel Onyx 3280, 40-channel Onyx 4080, and the flagship 48-channel Onyx 4880. The master section and channel strip configuration are the same for all four models, the only difference being number of channels.

The Onyx 80 Series consoles are equipped with our new premium precision-engineered studio-grade Onyx mic preamps. Mackie is renowned for the high-quality mic preamps used in our mixers, and the Onyx mic pre's are better than ever, with specifications rivaling expensive stand-alone mic preamplifiers.

Each mono channel strip features an individual phantom power switch, low-cut filter, polarity switch, pre-EQ channel insert, and an all new four-band EQ design with sweepable mids and EQ bypass switch.

All mono channels have eight Aux sends with a stereo-link function (can provide up to four IEM mixes), Pan, Mute and Mute Group assign, PFL Solo, 100 mm Fader, Group and Main Mix assign, and four signal-level indicators. In addition, balanced direct outputs are provided on DB-25 connectors (eight channels per connector) for multitrack recording.

The master section features eight stereo Aux inputs, eight Master Aux sends, eight Group Masters, an Aux/Group Flip function, a 10x2 Matrix, a Phones/Monitor section, and a Talkback section with routing switches that allow you to communicate through the Aux Sends, Group outputs, or the L/R mix.

Please write your serial number here for future reference (i.e., insurance claims, tech support, return authorization, etc.)

Purchased at:

Date of purchase:

HOW TO USE THIS MANUAL

We know that many of you can't wait to get your new mixing console hooked up, and you're probably not going to read the manual first (sigh!). So the next section is a Quick-Start Guide to help you get the mixer set up fast so you can start using it right away. Right after that are the ever popular hook-up diagrams that show typical mixer setups for live sound, recording and mixdown.

Then, when you have time, read the Features Description section. This describes every knob, button, and connection point on the Onyx 80 Series, roughly following the signal flow through the mixer.

Throughout this section you'll find illustrations with each feature numbered. If you want to know more about a feature, simply locate it on the appropriate illustration, notice the number attached to it, and find that number in the nearby paragraphs.



This icon marks information that is critically important or unique to the Onyx 80 Series. For your own good, read them and remember them. They will be on the final test.



This icon leads you to in-depth explanations of features and practical tips. While not mandatory, they usually have some valuable nugget of information.

A PLUG FOR THE CONNECTOR SECTION

Appendix B is a section on connectors: XLR connectors, balanced connectors, unbalanced connectors, and special hybrid connectors.

More resources on our website at www.mackie.com.

THE GLOSSARY: A Haven of Non-Techiness for the Neophyte

The "Glossary of Terms" is a fairly comprehensive dictionary of pro-audio terms. If terms like "clipping," "noise floor," or "unbalanced" leave you blank, refer to this glossary for a quick explanation.

ARCANE MYSTERIES ILLUMINATED

"Arcane Mysteries" discusses some of the down 'n' dirty practical realities of microphones, fixed installations, grounding, and balanced versus unbalanced lines. It's a goldmine for the neophyte, and even the seasoned pro might learn a thing or two.

Getting Started

READ THIS PAGE!!

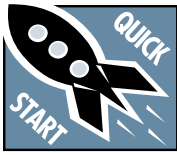

Even if you're one of those people who never read manuals, all we ask is that you read this page now before you begin using the Onyx 80 Series. You'll be glad you did!

Zero the Controls

1. Turn down the channel GAIN, AUX, and Fader controls, and center the channel EQ and PAN controls.
2. Set all push button switches to their "out" positions.
3. In the Master section, turn all the rotary knobs "down," the switches "out," and the faders down.
4. Turn the POWER switch off.

Connections

If you already know how you want to connect the Onyx 80 Series mixing console, go ahead and connect the inputs and outputs the way you want them. If you just want to get sound through the mixer, follow these steps:

1. Plug a microphone or other signal source into channel 1's MIC or LINE input [67/68]. If it's a line-level input, push in the LINE [2] switch.
2. Plug in the detachable linecord, connect it to an AC outlet, and turn on the Onyx 80 Series' POWER switch [85].
3. Connect cords from the Onyx 80 Series' MAIN OUTS [79] (XLR connectors or 1/4" TRS connectors on the rear panel) to your amplifier.
4. Hook up speakers to the amp and turn it on. If the amplifier has level controls, set them however the manufacturer recommends (usually all the way up).

Set the Levels

To set the channel GAIN controls, it's not even necessary to hear what you're doing at the outputs of the mixer. If you want to listen while you work, plug headphones into the PHONES jack [65] on the front panel, then set the PHONES knob [64] about one-quarter of the way up and the SOLO LEVEL [61] about halfway up.

The following steps must be performed one channel at a time.

1. Push in the channel's PFL [22] solo switch.
2. Play something into the selected input. This could be an instrument, a singing or speaking voice, or

a line input such as a CD player or tape recorder output. Be sure that the volume of the input source is the same as it would be during normal use. If it isn't, you might have to readjust these levels during the middle of the set.

3. Adjust the channel's GAIN [5] control so that the LEDs on the Left Solo meter stay around "0" and never go higher than "+7."
4. If you'd like to apply some EQ, do so now and return to step 3. Remember to push in the EQ IN/OUT [12] button or the EQ controls won't do anything.
5. Disengage that channel's PFL solo switch.
6. Repeat for each channel.

Instant Mixing

1. Leave the microphone plugged into channel 1 and connect a keyboard, guitar or other instrument to channel 2. Be sure to "Set the Levels" for channel 2 as described above.
2. To get sound out of the speakers, push in the MAIN MIX assign switch [21] next to the faders on channels 1 and 2, turn up channel 1 and 2 faders [33] to the "U" mark and slowly turn up the left and right MAIN MIX [60] faders to a comfortable listening level.
3. Sing and play. You're a star! Adjust the faders for channels 1 and 2 to bring your voice and your instrument up and down to create your own mix.

Other Nuggets of Wisdom

- For optimum sonic performance, the channel and MAIN MIX faders should be set near the "U" (unity gain) markings.
- Always turn the MAIN MIX faders, GROUP faders, and MONITOR knob down before making connections to and from your Onyx 80 Series.
- When you shut down your equipment, turn off the amplifiers first. When powering up, turn on the amplifiers last.
- Never listen to loud music for prolonged periods. Please see the Safety Instructions on page 2 for information on hearing protection.
- Save the shipping box! You may need it someday, and you don't want to have to pay for another one.

That's it for the "Getting Started" section. Next comes the "Hookup" section that shows you some typical ways that you might use the Onyx 80 Series in real applications. After that, take the grand tour of the mixer, with descriptions of every knob, button, input, and output. We encourage you to take the time to read all of the feature descriptions, but at least you know it's there if you have any questions.

Hookup Diagrams

This hookup diagram demonstrates how you can do a live multitrack recording using the DIRECT OUTs. The DIRECT OUTs provide an analog balanced direct output for each channel, post-EQ.

Aux Send 1 is used for stage monitors, and Aux Sends 3 and 4 are a stereo pair driving an IEM system. Aux Sends 5/6 and 7/8 could provide two more stereo sends for IEM systems.

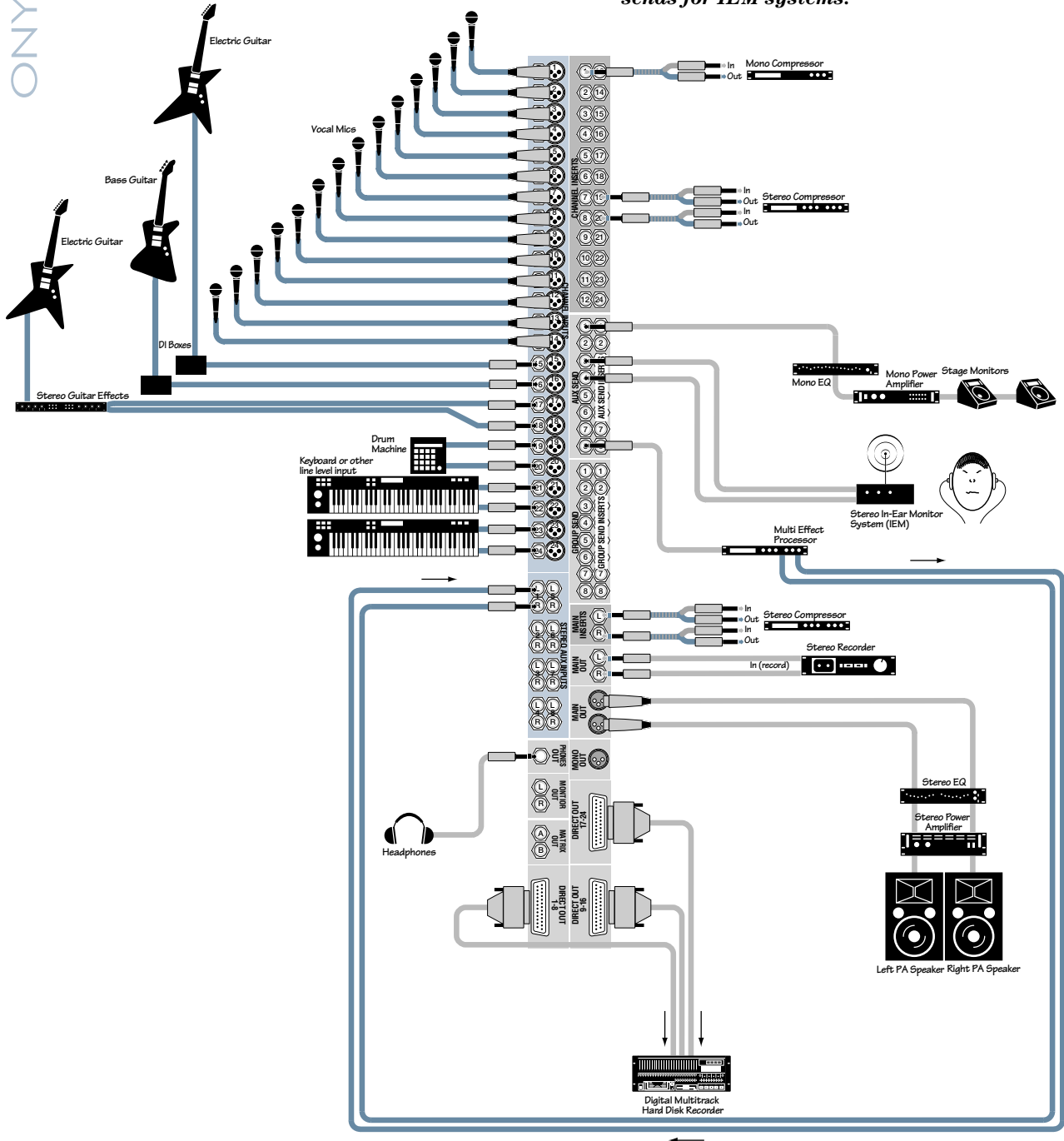

Onyx 2480 Live Mix and Multitrack Recording

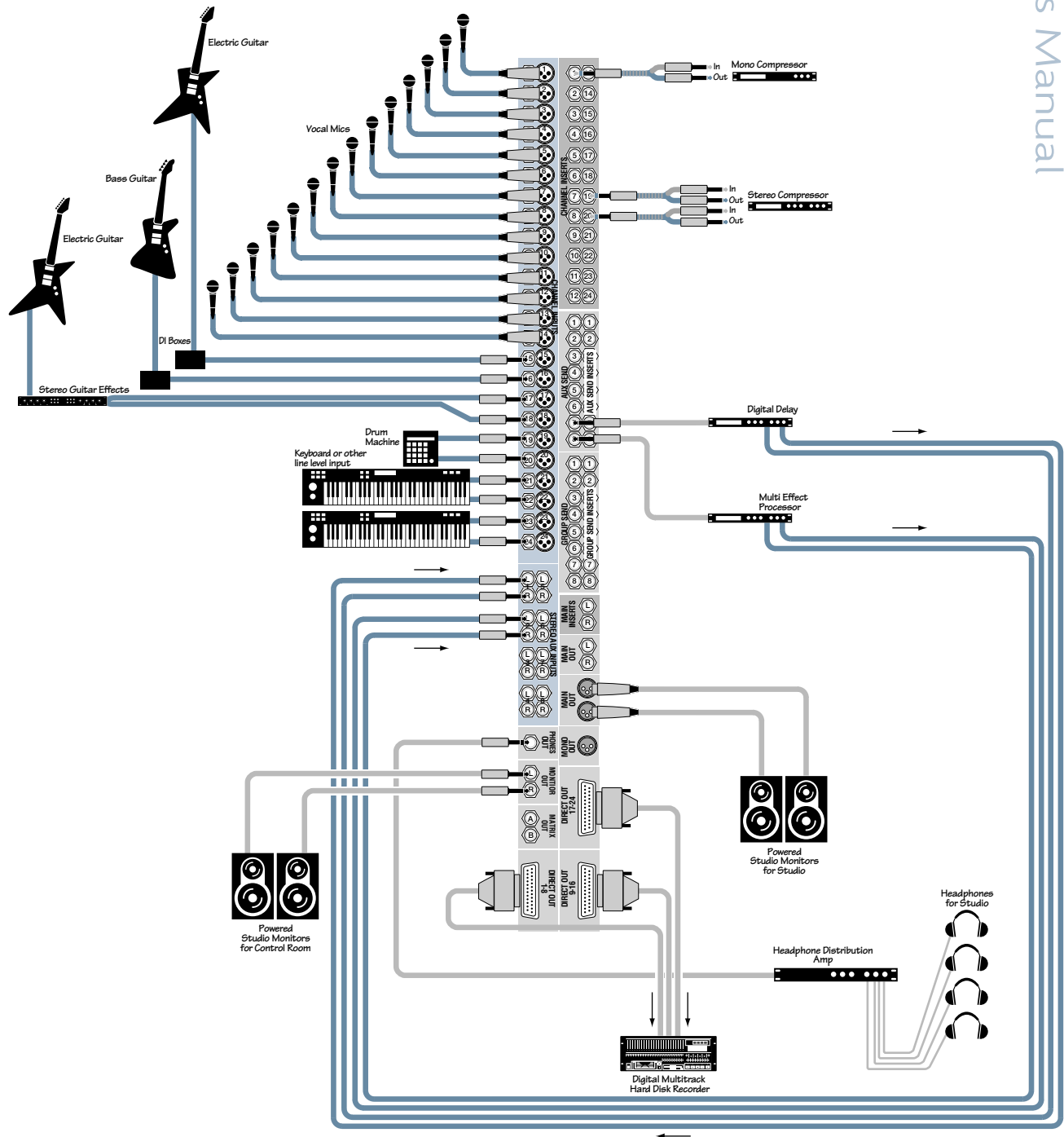

The DIRECT OUTs provide an analog balanced direct output for each channel, tapped after the GAIN control and EQ controls. The Main Outs are used for monitors in the studio, and the Monitor Outs are used for monitors in the control room. In addition, the Phones Out drives a headphone distribution amplifier to provide individual monitor level control for the talent.

Onyx 2480 Multitrack Recording in a Studio (Tracking)

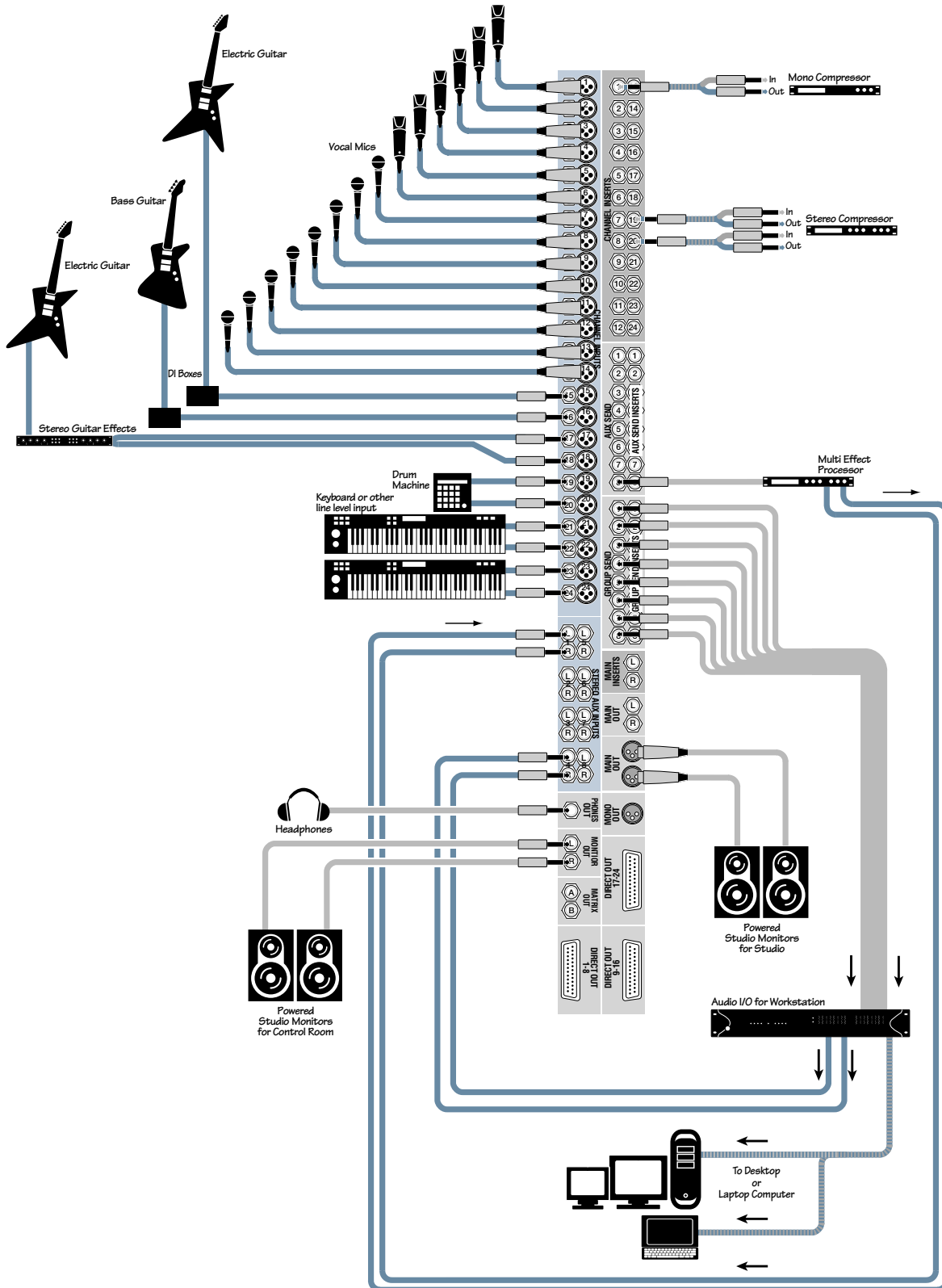

In this hookup diagram, the tracking channels are routed to the Group 1-8 outputs. These are connected to the analog audio interface to your DAW or laptop. A 2-track return is provided by the DAW (or laptop) to Stereo Aux Input 4 on the Onyx 2480 for playback of the master mix.

Onyx 2480 Computer Recording

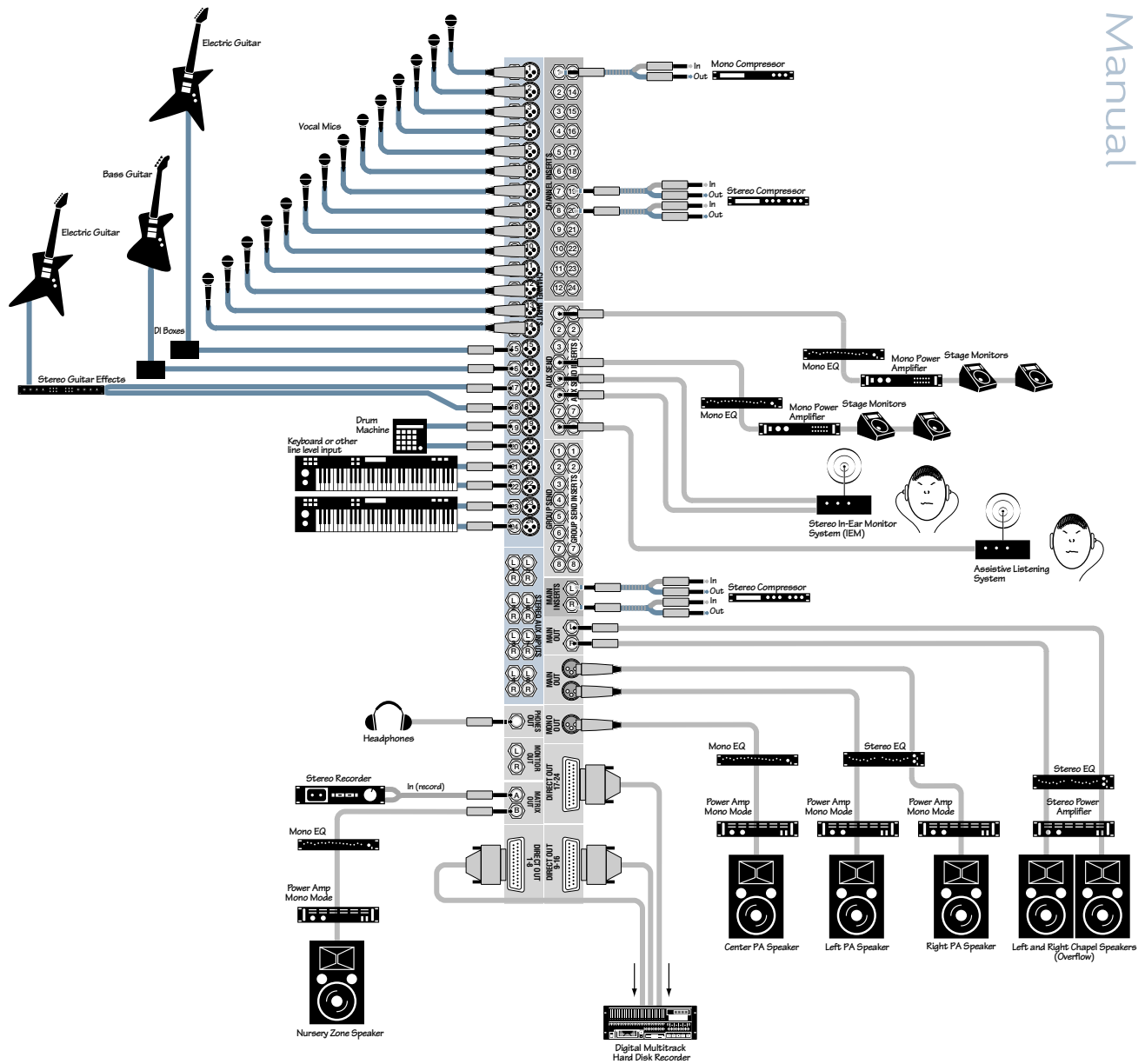

In a House of Worship application, the Onyx 80 Series provides plenty of Aux Sends for stage monitors, stereo in-ear monitoring, and assistive listening systems. The MONO output is used for the center PA speaker located between the Left and Right speakers. The 1/4-inch Main Outputs provide a feed to the chapel for overflow needs. The Matrix A output provides a custom mix for a mono recording and the Matrix B output provides a custom mix for the nursery.

Onyx 2480 House of Worship

Onyx 80 Series Features

Channel Strips

Depending on the model that you purchased, there are 24, 32, 40, or 48 channel strips. Each channel has a mic and line input connector and an insert jack for connecting an external signal processor.

1. 48V Phantom Power Switch

Most professional condenser microphones require phantom power, which is a low-current DC voltage delivered to the microphone on pins 2 and 3 of the XLR microphone connector. Push in the 48V button if your microphone needs phantom power. An LED lights just above the button to indicate that phantom power is active on that channel.

Dynamic microphones, like Shure's SM57 and SM58, do not require phantom power. However, phantom power will not harm most dynamic microphones should you accidentally plug one in while the phantom power is turned on. Be careful with older ribbon microphones. Check the manual for your microphone to find out for sure whether or not phantom power can damage it.

Note: Be sure the MAIN MIX faders [60] are turned down when connecting microphones to the MIC Inputs, especially when phantom power is turned on, to prevent pops from getting through to the speakers.

2. MIC/LINE Switch

This button switches between the MIC and LINE inputs. When the button is out (MIC), the XLR MIC input is used and the LINE input is disconnected. When the button is pushed in, the 1/4" input is used and the XLR MIC input is disconnected.

3. Low-Cut Switch

The Low-Cut switch, often referred to as a high-pass filter, cuts bass frequencies below 100 Hz at a rate of 18 dB per octave.

We recommend that you use the Low-Cut filter on every microphone application except kick drum, bass guitar, bassy synth patches, or recordings of earthquakes. These aside, there isn't much down there that you want to hear, and filtering it out makes the low stuff you do want much more crisp and tasty. Not only that, but the Low-Cut filter can help reduce the possibility of feedback in live situations and it helps to conserve amplifier power.



Another way to use the Low Cut filter is in combination with the LOW EQ on vocals during live performances. Many times, bass shelving EQ can really benefit voices. Trouble is, adding LOW EQ also boosts stage rumble, mic handling clunks, and breath pops. Low Cut removes all those problems so you can add LOW EQ without losing a woofer.

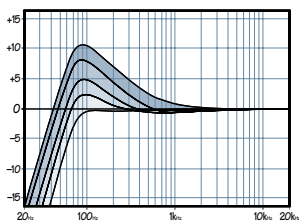

Here's what the combination of LOW EQ and Low Cut looks like in terms of frequency curves.

Low Cut with Low EQ Boosted

4. Polarity Switch

Pushing in this switch simply reverses the polarity of the signal. This provides an easy way to correct a microphone or line source whose polarity is opposite from the other microphones, either from a miswired cable or from not following the AES standard for Pin 2/Pin 3.

5. GAIN Control

If you haven't already, please read "Set the Levels" on page 5.

The GAIN control adjusts the input sensitivity of the mic and line inputs. This allows the signal from the outside world to be adjusted to optimal internal operating levels.

If the signal is plugged into the XLR jack, there is 0 dB of gain (unity gain) with the knob turned all the way down, ramping up to 60 dB of gain fully up.

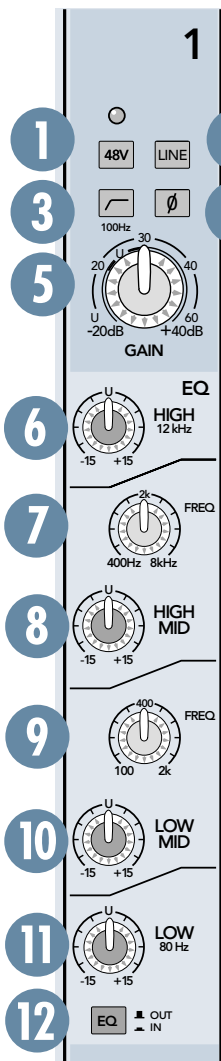

When connected to the 1/4" jack, there is 20 dB of attenuation all the way down, and 40 dB of gain fully up, with a "U" (unity gain) mark at about 10:00.

6. HIGH EQ

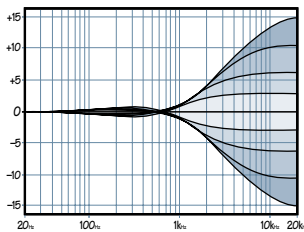

High EQ

This control gives you up to 15 dB boost or cut at 12 kHz, and it is also flat at the center detent. Use it to add sizzle to cymbals, and an overall sense of transparency or edge to the keyboards, vocals, guitar, and bacon

frying. Turn it down a little to reduce sibilance, or to hide tape hiss.

7. HIGH MID EQ

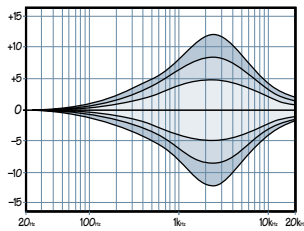

High Mid EQ

Short for "midrange," this knob provides 15 dB of boost or cut centered at the frequency determined by its **FREQ** knob (see **HIGH MID FREQ** next). Midrange EQ is often thought of as the

most dynamic because the frequencies that define any particular sound are almost always found in this range. The **HIGH MID EQ** range (400 Hz to 8 kHz) includes the female vocal range as well as the fundamentals and harmonics for many instruments.

8. HIGH MID FREQ

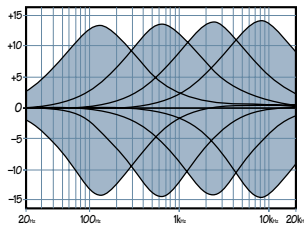

Mid EQ Freq Sweep

This knob ranges from 400 Hz to 8 kHz and determines the center frequency for the **HIGH MID EQ** filter. This allows you to zero in on the precise narrow band of frequencies you want to have affected by the **HIGH MID EQ**.

9. LOW MID EQ

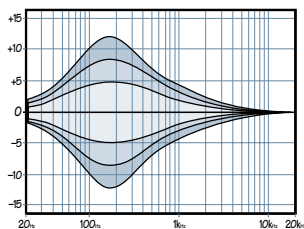

Low Mid EQ

This is a second mid-range EQ control that provides 15 dB of boost or cut centered at the frequency determined by its **FREQ** knob. It extends down to 100 Hz, which includes

the male vocal range and the fundamentals of some lower instruments (guitar, lower brass).

10. LOW MID FREQ

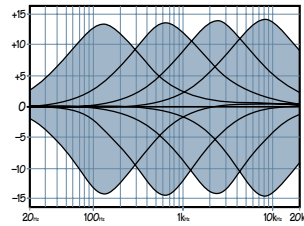

Mid EQ Freq Sweep

This knob ranges from 100 Hz to 2 kHz and determines the center frequency for the **LOW MID EQ** filter. This allows you to zero in on the precise narrow band of frequencies you want to have affected by the **LOW MID EQ**.

11. LOW EQ

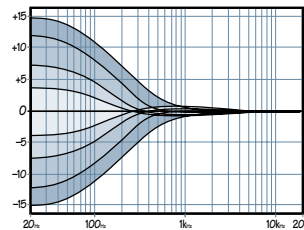

Low EQ

This control gives you up to 15 dB of boost or cut at 80 Hz. The circuit is flat (no boost or cut) at the center detent position. This frequency represents the punch in bass drums, bass guitar, fat synth patches, and some really serious male singers.

Note: Used in conjunction with the Low Cut switch, you can boost the **LOW EQ** without injecting tons of infrasonic debris into the mix.

12. EQ IN/OUT Switch

This is a true hardware bypass of the Perkins EQ circuitry to insure that there is no coloration of the signal if the EQ is not needed. When this button is out, the EQ controls have no effect on the signal. You can use this switch to make an A/B comparison between the EQ'd signal and the signal without EQ.



We have completely redesigned the EQ circuits in the Onyx Series of mixers, based on the designs of Cal Perkins, an industry-leader in audio engineering for over three decades and long-time Mackie collaborator.

This "neo-classic" design provides the sweet musicality of the British EQ sound, while still maintaining 15 dB of boost and cut with optimum Q and minimum phase shift (in other words, it gives you plenty of control and is pleasing to the ear!).

The 4-band equalization has **LOW** shelving at 80 Hz, **LOW MID** peaking, sweepable from 100 Hz to 2 kHz on the mono channels, **HIGH MID** peaking, sweepable from

400 Hz to 8 kHz on the mono channels, and HIGH shelving at 12 kHz. “Shelving” means that the circuitry boosts or cuts all frequencies past the specified frequency. For example, rotating the LOW EQ knob 15 dB to the right boosts bass frequencies below 80 Hz and continuing on down to the lowest note you ever heard. “Peaking” means that the frequencies around the center frequency are less affected by the EQ the further away they are.

13. AUX Sends

These tap a portion of each channel’s signal out to either an effects processor or for stage monitoring. The AUX Send levels are controlled by the channel’s AUX 1-8 knobs, and by the AUX MASTER 1-8 knobs [37].

These are more than just effects and monitor sends. They can be used to create stereo in-ear monitor mixes, generate separate mixes for recording, for another zone, or “mix-minuses” for broadcast.

14. PRE Switch

This switch is used to select whether the Aux send signal is pre-fader or post-fader. When the PRE switch is up, the Aux send signal is post-fader, which is usually used when you are using the Aux send to go to an effects processor. This way, when fader changes are made, the “wet” signal going to the effects processor moves up and down along with the “dry” signal, maintaining a balance between them.

When the PRE switch is pushed in, the Aux send signal is pre-fader, which is usually used for sending to monitors (stage monitor wedges or IEM, in-ear monitor systems). This way, when changes are made to fader levels in the front-of-house mix, it doesn’t affect the monitor mix.

The pre-fader Aux Sends are post-EQ by default. However, an internal jumper is provided on each channel to change the pre-fader Aux Sends to pre-EQ, if desired. This requires some soldering skills, so contact Tech Support for information on how to access the pre/post-EQ jumpers for the Aux Sends.

15. STEREO Switch

When this switch is pushed in, the associated odd/even pair of Aux sends become a stereo send and pan control, respectively. For example, if you press the STEREO switch for Aux 1 and 2, the Aux 1 knob controls the signal level to both Aux 1 and Aux 2, and the Aux 2 knob controls the panning of the signal between Aux 1 and 2. This is useful for providing a stereo mix for IEM (in-ear monitor) systems.

16. PAN

PAN adjusts the amount of channel signal sent to the left versus the right outputs.

With the PAN knob hard left, the signal feeds the MAIN LEFT (and GROUP 1, 3, 5, and 7, depending on the setting of the GROUP ASSIGN switches). With the knob hard right, the signal feeds the MAIN RIGHT (and GROUP 2, 4, 6, and 8).

Constant Loudness



The Onyx 80 Series PAN control employs a design called “Constant

Loudness.” If you have a channel panned hard left (or right) and then pan to the center, the signal is attenuated 3 dB to maintain the same apparent loudness. Otherwise, it would make the sound appear much louder when panned center.

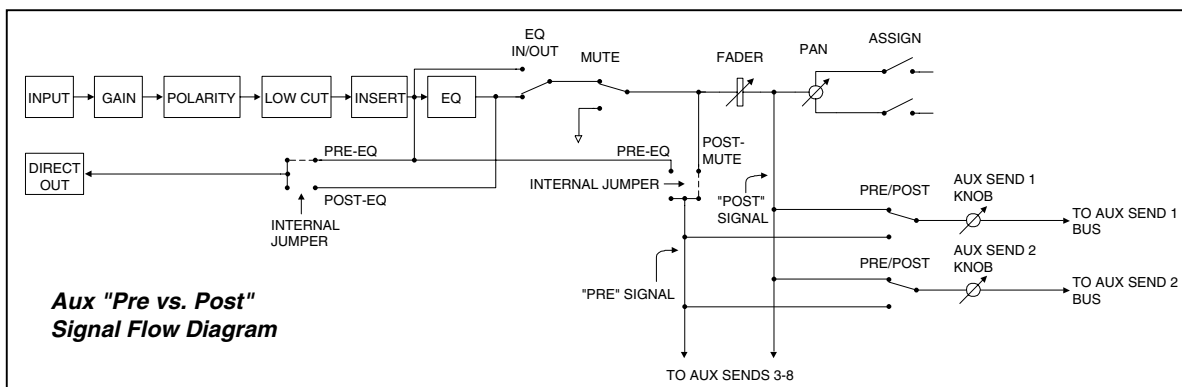
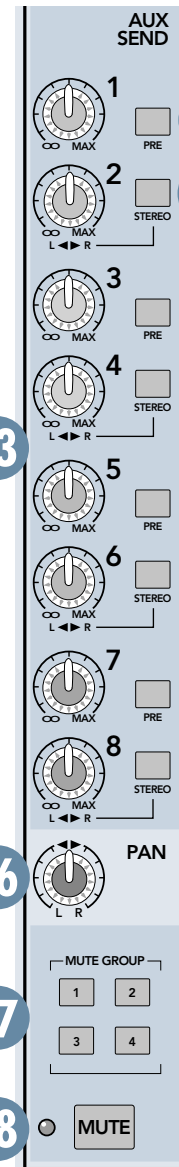

17. MUTE GROUP Assign Switches

Use these switches to assign the channel to one or more mute groups. The master mute groups [54] are located in the Master section next to the Talkback section. When a master mute group switch is pressed, all the channels assigned to that mute group are muted. This makes it easy to mute a number of channels all at once, for example, all the drum mics or all the vocal mics.

18. MUTE

Press this switch to mute the individual channel. This disconnects the channel's signal from all the Groups, the Main Mix, and Aux Send buses (pre* and post-fader). You can still solo the channel (PFL) when the MUTE switch is pushed in.

* If the pre-fader Aux Send's internal jumper is wired for pre-EQ [14], the MUTE switch will not affect the PRE Aux Send.

19. Channel Fader

The fader controls the channel's level... from off to unity gain at the "U" marking, on up to 10 dB of additional gain.

"U" Like Unity Gain



Mackie mixers have a "U" symbol on almost every level control. This "U" stands for "unity gain," meaning no change in signal level. Once you have adjusted the input signal to line-level, you can set every control

at "U" and your signals will travel through the mixer at optimal levels. What's more, all the labels on our level controls are measured in decibels (dB), so you'll know what you're doing level-wise if you choose to change a control's settings.

20. Signal Level LEDs

These LEDs indicate the channel's signal level after the GAIN and EQ controls, but just prior to the channel's fader. So even if the fader is turned down, you can see if a signal is present.

If you've followed the "Set the Levels" procedure, the -20 and 0 LEDs should light frequently, the +10 LED should light occasionally, and the OL (Overload) LED should not light at all. If the OL LED is blinking frequently, the signal is probably distorted from overdriving the input. Either turn down the GAIN control or turn down the signal at its source.

21. GROUP and MAIN MIX ASSIGN Switches

Alongside each channel fader are five buttons referred to as channel assignment switches. Used in conjunction

with the channel's PAN knob, they are used to determine the destination of the channel's signal.

With the PAN knob [12] at the center detent, the left and right sides receive equal signal levels (GROUPS 1-2, 3-4, 5-6, 7-8, and MAIN MIX L-R). To feed only one side or the other, turn the PAN knob accordingly.

If you're doing a mixdown to a 2-track, for example, simply engage the MAIN MIX switch on each channel that you want to hear, and they'll be sent to the MAIN MIX bus. If you want to create a subgroup of certain channels, engage either the 1-2, 3-4, 5-6, or 7-8 switches instead of the MAIN MIX, and they'll be sent to the appropriate Group faders. From there, the groups can be sent back to the MAIN MIX (using the MAIN MIX assign switches [41] above the Group faders), allowing you to use the Group faders as a master control for those channels.

If you're creating new tracks or bouncing existing ones, you'll also use the GROUP ASSIGN switches, but not the MAIN MIX switch. Here, you don't want the subgroups sent back into the MAIN MIX bus, but sent out, via the GROUP SEND jacks [74], to your multitrack inputs. However, if you're printing tracks via the DIRECT OUTS [70], the channel assignment switches don't matter because the DIRECT OUTS come before the ASSIGN switches.

22. PFL SOLO Switch

This handy switch allows you to hear signals through your headphones or monitor outputs without having to route them to the MAIN or GROUP mixes. Folks use solo in live work to preview channels before they are let into the mix, or just to check out what a particular channel is up to anytime during a session. You can solo as many channels at a time as you like.

The Onyx 80 Series has two solo modes. PFL (Pre-Fader Listen) is the default solo mode, and the mode used for soloing individual channels and the stereo Aux Inputs. AFL (After-Fader Listen) is activated whenever an AFL switch is pressed on an Aux Send, Matrix, or Group.

PFL solo mode always overrides any AFL solo mode. The Rude Solo LEDs below the SOLO meters indicate which solo mode is active.

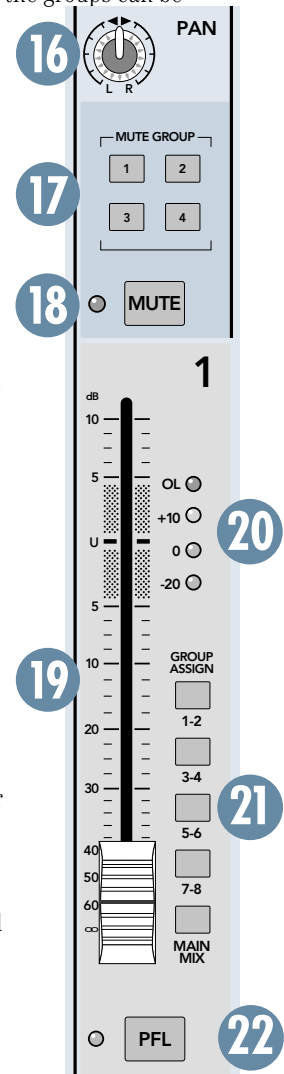

Soloed channels are sent to the PHONES output, MONITOR outputs, and SOLO Meters. PFL mode (Pre-Fader Listen) sends the channel's signal after the GAIN and EQ controls, but before the channel fader, to the PFL solo bus. AFL mode (After-Fader Listen), sends the signal post-fader, making it ideal for mixdown soloing.



VERY IMPORTANT: Remember, PFL mode taps the channel signal before the fader. If you have a channel's fader set way below "U" (unity gain), PFL solo won't know that and will send a unity gain signal to the MONITOR OUT, PHONES output, and meter display. That may result in a startling level boost at these outputs when switching from AFL to PFL mode.

Auxiliary Section

This section includes the AUX MASTERS (Sends) and the STEREO AUX INPUTS. These can be a bit confusing to the uninitiated, so here's the whole idea behind aux sends and inputs: sends are outputs and inputs are inputs. AUX SENDS tap signals off the channels, via the AUX knobs [13], mix these signals together, then send them out the AUX SEND jacks [72].

These outputs are fed to the inputs of an external processor like a reverb or digital delay. From there, the mono or stereo outputs of this external device are fed back to the mixer's STEREO AUX INPUT jacks [71]. These signals are sent through the AUX INPUT faders [33], and finally delivered to a GROUP [43] and/or the MAIN MIX [60], depending on the ASSIGN [35] switches.

So, the original "dry" signals go from the channels to the MAIN MIX and the affected "wet" signals go from the AUX INPUTS to the MAIN MIX, and once mixed together, the dry and wet signals combine to create a glorious sound!

The AUX SENDS can also be used to provide another mix for stage monitors, for example. In this case, the AUX INPUTS aren't used to return the signal. Instead, they can be used as additional stereo inputs.

Stereo Aux Input Section

The stereo Aux Inputs can be used as mono or stereo line-input channel strips, or to return the signal from an external effects processor connected to an Aux Send. These versatile channel strips are nearly as full-featured as the mono channel strips.

23. GAIN Control

If you haven't already, please read "Set the Levels" on page 5.

The GAIN control adjusts the input sensitivity of the stereo line inputs. This allows the signal from the outside world to be adjusted to optimal internal operating levels.

There is 20 dB of attenuation with the knob turned all the way down, ramping up to 20 dB of gain fully up, with a "U" (unity gain) mark at 12:00.

24. HIGH EQ

This control gives you up to 15 dB boost or cut above 12 kHz, and it is also flat at the center detent. Use it to add sizzle to cymbals, and an overall sense of transparency or edge to the keyboards, vocals, guitar, and bacon frying. Turn it down a little to reduce sibilance, or to hide tape hiss.

25. HIGH MID EQ

Short for "midrange," this knob provides 15 dB of boost or cut at 2.5 kHz. Midrange EQ is often thought of as the most dynamic because the frequencies that define any particular sound are almost always found in this range. The HIGH MID EQ frequencies include the female vocal range as well as the fundamentals and harmonics for many instruments.

26. LOW MID EQ

This is a second midrange EQ control that provides 15 dB of boost or cut centered at 400 Hz. This includes the male vocal range and the fundamentals of some lower instruments (guitar, lower brass).

27. LOW EQ

This control gives you up to 15 dB of boost or cut below 80 Hz. The circuit is flat (no boost or cut) at the center detent position. This frequency represents the punch in bass drums, bass guitar, fat synth patches, and some really serious male singers.

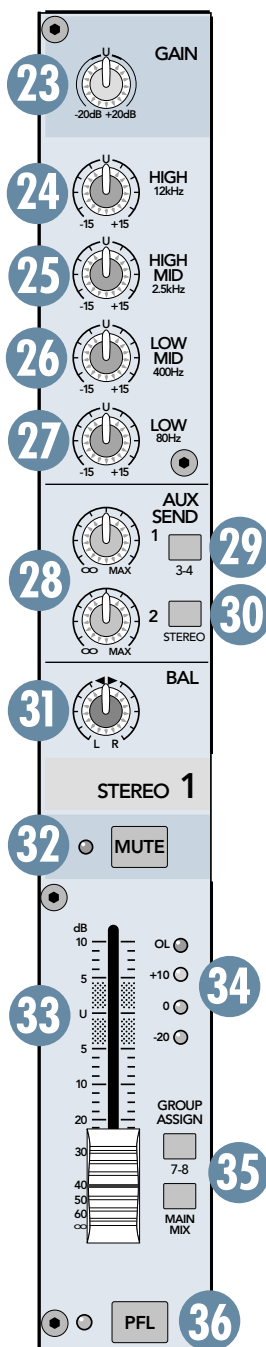

28. AUX SEND 1 and 2 (Aux Inputs 1-4) AUX SEND 5 and 6 (Aux Inputs 5-8)

These tap a portion of each channel's signal out to either an effects processor or for stage monitoring. These go to the same Aux Send buses as the mono channel Aux Sends. The Aux Input Aux Sends are always pre-fader.

Aux Inputs 1-4 send their signals to Aux 1 and Aux 2. Aux Inputs 5-8 send their signals to Aux 5 and 6.



FEEDBACK LOOP WARNING: It is common to use an Aux Send to route signals to an external processor, and then return the signal from the processor via the Aux Inputs. Since the Aux Inputs on the Onyx 80 Series have Aux Sends of their own, you could accidentally route the Aux Input to an Aux Send that is being returned via that same Aux Input. This will cause a feedback loop, characterized by a LOUD howl or screech through the sound system, followed by howls of discontent from the audience. *Be careful* with the Aux Sends on the Aux Inputs!

29. AUX 3-4 Switch (Aux Inputs 1-4) AUX 7-8 Switch (Aux Inputs 5-8)

For Aux Inputs 1-4:

Press this switch to send the Aux Input signal to the Aux 3 and 4 buses instead of the Aux 1 and 2 buses. The Aux 1 and 2 knobs for that channel strip suddenly become Aux 3 and 4 knobs!

For Aux Inputs 5-8:

Press this switch to send the Aux Input signal to the Aux 7 and 8 buses instead of the Aux 5 and 6 buses. The Aux 5 and 6 knobs for that channel strip suddenly become Aux 7 and 8 knobs!

30. STEREO Switch

When this switch is up, both Aux Sends are fed a mono sum of the stereo channel's signal (L+R).

When this switch is pushed in, the two Aux sends become a stereo send, with Aux 1 sending the right signal and Aux 2 sending the left signal. The same thing applies when Aux 3-4 is selected for Aux Inputs 1-4, and for Aux 5 and 6 (and Aux 7-8) for Aux Inputs 5-8.

This is useful for providing a stereo mix for IEM (in-ear monitor) systems.

31. BALANCE

BALANCE adjusts the amount of channel signal sent to the left versus the right outputs. On the stereo Aux Input channels, the BALANCE knob works like the bal-

ance control on your home stereo (panning left turns down the right channel, and panning right turns down the left channel).

32. MUTE

Press this switch to mute the channel. This disconnects the channel's signal from all the Groups, the Main Mix, and Aux Send buses. You can still solo the channel in PFL mode when the MUTE switch is pushed in.

33. Stereo Aux Input Fader

The fader controls the stereo channel's level, from off to unity gain at the "U" marking, on up to 10 dB of additional gain.

34. Signal Level LEDs

These LEDs indicate the channel's signal level after the GAIN and EQ controls, but just prior to the channel's fader. So even if the fader is turned down, you can see if a signal is present.

If you've followed the "Set the Levels" procedure, the -20 and 0 LEDs should light frequently, the +10 LED should light occasionally, and the OL (Overload) LED should not light at all. If the OL LED is blinking frequently, the signal is probably distorted from overdriving the input. Either turn down the GAIN control or turn down the signal at its source.

35. GROUP and MAIN MIX ASSIGN Switches

Alongside each channel fader are two buttons referred to as channel assignment switches. Used in conjunction with the channel's BALANCE knob, they are used to determine the destination of the channel's signal.

The Aux Inputs are assignable to GROUPS 7-8 and the MAIN MIX. With the BALANCE knob [31] at the center detent, the left and right stereo signal is equally balanced. To feed only one side or the other, turn the BALANCE knob accordingly.

36. PFL Solo Switch

Like the PFL switch on the mono channels, this switch allows you to hear signals through your headphones or monitor outputs without having to route them to the MAIN or GROUP mixes. Since this is Pre-Fader Listen, you can listen to the stereo Aux Input even when the Aux Input fader is turned down. Unlike the mono channel PFL, the Aux Input PFL is a stereo signal (post-balance control).

PFL solo mode always overrides AFL solo mode. The Rude Solo LEDs below the SOLO meters indicate which solo mode is active.

Master Aux Send Section

37. AUX 1-8 MASTERS

The AUX MASTERS provide overall control over the AUX SEND levels, just before they are delivered to the AUX SEND outputs [72]. These knobs go from off (∞) to +15 dB when turned all the way up.

This is usually the knob you turn up when the lead singer glares at you, points at his stage monitor, and sticks his thumb up in the air. (It would follow that if the singer stuck his thumb down, you'd turn the knob down, but that never happens.)

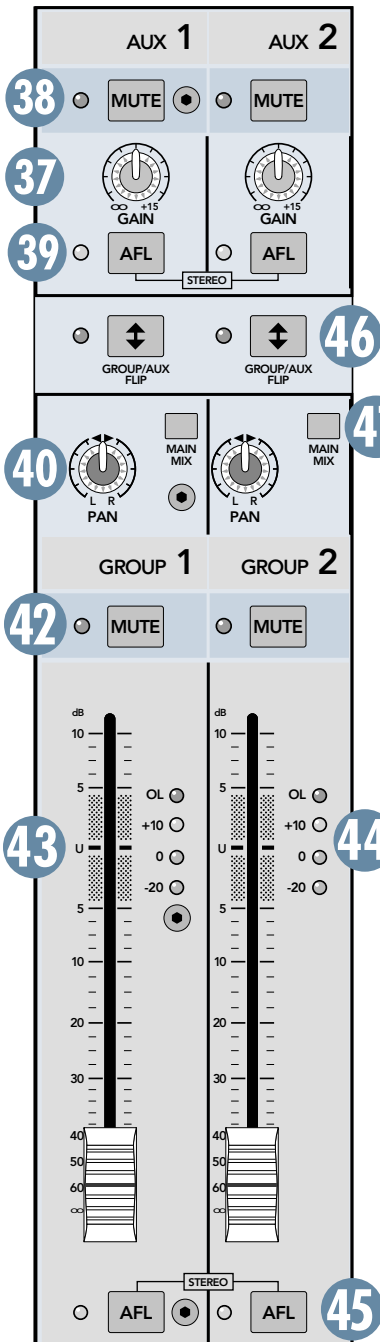

38. MUTE

Press this switch to mute the Aux Send output. When the MUTE switch is pushed in on an Aux Send, you can still solo the Aux Send (see AFL Solo Switch next).

39. AFL Solo Switch

The AFL switch allows you to hear the Aux Send signal through your headphones or monitor outputs. This comes after the Aux Send GAIN control, so you can hear the relative signal level on each Aux Send.

When you engage the AFL switch on two consecutive odd/even Aux Sends (i.e., 1 and 2, 3 and 4, etc.), the soloed signal appears in stereo in the headphones and monitor outputs. This is useful when you are using a pair of Aux Sends in stereo to feed an in-ear monitoring system.

Remember, PFL solo mode always overrides AFL solo mode. If you engage a PFL solo switch on a mono or stereo channel, the AFL solo is disconnected from the headphones and monitor outputs and replaced with the PFL signal. The Rude Solo LEDs below the SOLO meters indicate which solo mode is active.

Group Section

There are eight group masters (or submasters, if you prefer) that feed the eight group sends [74].

40. PAN

Note: The Group PAN control works only when the MAIN MIX switch is engaged (see next).

PAN adjusts the amount of signal sent to the left versus the right outputs.

With the PAN knob hard left, the signal feeds the MAIN LEFT output, and with the knob hard right, the signal feeds the MAIN RIGHT output.

41. MAIN MIX Assign Switch

Push in this switch to send the Group signal to the left and right MAIN OUTS. When the PAN control is centered, the signal is sent equally to the left and right outputs.

The signal sent to the MAIN OUTS is after the Group Insert, Fader, and MUTE switch.

42. MUTE Switch

Press this switch to mute the Group output. When the MUTE switch is pushed in on a Group, you can still solo the Group signal (see AFL Solo Switch [39] ahead).

43. GROUP Fader

This fader controls the Group's signal level, from off to unity gain at the "U" marking, on up to 10 dB of additional gain.

44. Signal Level LEDs

These LEDs indicate the Group's signal level after the Fader and MUTE switch. So if the MUTE switch is pushed in or the Faders are down, the Signal Level LEDs won't light.

45. AFL Solo Switch

The AFL switch allows you to hear the Group signal through your headphones or monitor outputs. This comes after the Group Fader and before the MUTE switch, so you can hear the relative signal level on each Group even when they are muted.

When you engage the AFL switch on two consecutive odd/even Groups (i.e., 1 and 2, 3 and 4, etc.), the soloed signal appears in stereo in the headphones and monitor outputs. This is useful when you are using a pair of Group Sends in stereo to feed an in-ear monitoring system.

Remember, PFL solo mode always overrides AFL solo mode. If you engage a PFL solo switch on a mono or stereo channel, the AFL solo is disconnected from the headphones and monitor outputs and replaced with the PFL signal. The Rude Solo LEDs below the SOLO meters indicate which solo mode is active.

46. GROUP/AUX FLIP Switch

This switch “flips” the controls for the Aux Sends and the Group Sends, so that the Group Faders control the Aux Send levels, and the Aux Send GAIN controls adjust the Group levels. The Group signals still appear at the GROUP SEND outputs and the Aux Send signals still appear at the AUX SEND outputs.

This allows you to use the long-throw (100 mm) Group Fader to make more precise settings for the Aux Sends, if required.

The following chart shows what happens to each control in the Aux Send and Group sections when the GROUP/AUX FLIP Switch is pushed in:

With GROUP/AUX FLIP Switch Down			
Aux Send Control	Function	Group Control	Function
Aux Send MUTE	Mutes Group Signal	Group MUTE	Mutes Aux Send Signal
Aux Send GAIN	Adjusts Group Signal	Group Fader	Adjusts Aux Send Signal
Aux Send AFL	Solos Group Signal	Group AFL	Solos Aux Send Signal
		Signal Level LEDs	Indicates Aux Send Signal Level
		Main Mix Switch	Routes Group Signal to Main Mix
		Group PAN	Adjusts amount of Group Signal to left and right Main Mix

Metering, Matrix, and Power LEDs

47. POWER Indicators

These four LEDs indicate the status of the internal power supply voltages. The +15V and -15V supplies power the audio circuits, the +48V is the phantom power applied to the XLR MIC inputs (when the 48V switch is pushed in on the channel strips), and the -12V supply powers some internal relay circuits and the lamp connectors.

When all four LEDs are lit, you know that the internal power supply (or the external redundant power supply, if connected) is operating correctly.

48. SOLO Meters

The Onyx SOLO meters are made up of two columns of twelve LEDs, with three colors to indicate different ranges of signal level, traffic light style. They range from -30 at the bottom, to 0 in the middle, to +20 (CLIP) at the top.

If there are no channels in SOLO, the meters won't do anything. When a channel is soloed, the meters reflect the program level of the selected source prior to the SOLO, MONITOR, and PHONES [61/63/64] level knobs.

When a mono channel (or channels) is soloed, only the left meter indicates signal, confirming the monophonic status of the soloed signal. When a stereo Aux Input is soloed, or stereo AFL solo mode is selected, both meters indicate the corresponding left and right signals.

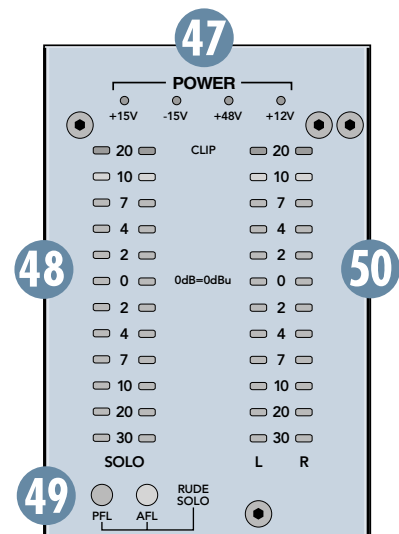

49. RUDE SOLO Lights

These LEDs flash on and off when a channel's solo is active, as an additional reminder beyond the indicating LEDs next to each PFL or AFL button. The green LED indicates PFL solo mode, and the amber LED indicates AFL solo mode. If you work on a mixer that has a solo function with no indicator lights and you happen to forget you're in solo mode, you can easily be tricked into thinking that something is wrong with your mixer. Hence, the RUDE SOLO lights. It's especially handy at about 3 am when no sound is coming out of your monitors but your multitrack is playing back like mad.

50. LEFT/RIGHT Level Meters

Like the SOLO meters, the Onyx 80 Series Left and Right Level meters are made up of two columns of twelve LEDs, with three colors to indicate different ranges of signal level, traffic light style. They range from -30 at the bottom, to 0 in the middle, to +20 (CLIP) at the top.

The 0 LED in the middle is labeled 0 dB = 0 dBu.



You may already be an expert at the world of "+4" (+4 dBu=1.23 V) and "-10" (-10 dBV=0.32 V) operating levels. What makes a mixer one or the other is the relative 0 dB VU (or 0 VU) chosen for the meters. A "+4" mixer, with +4 dBu pouring out the back will actually read 0 VU on its meters. A "-10" mixer, with a -10 dBV signal trickling out will read, you guessed it, 0 VU on its meters. So when is 0 VU actually 0 dBu? Right now!

Mackie mixers show things as they really are. When 0 dBu (0.775 V) is at the outputs, it shows as 0 dB VU on the meters. What could be easier? By the way, the most wonderful thing about standards is that there are so many to choose from.

Thanks to the Onyx 80 Series' wide dynamic range, you can get a good mix with peaks flashing anywhere between -20 and +10 dB on the meters. Most amplifiers clip at about +10 dBu, and some recorders aren't so forgiving either. For best real-world results, try to keep your peaks between "0" and "+7."

Remember, audio meters are just tools to help assure you that your levels are "in the ballpark." You don't have to stare at them (unless you want to).

51. MATRIX A and B Input Controls

The Matrix A and B controls allow you to create separate mixes, or a stereo mix, from Groups 1 through 8 and the Left and Right Mix outputs. Simply adjust the 10 input controls to create the mix you want at the MATRIX A or B outputs.

52. MATRIX A and B MASTER Controls

Use these controls to adjust the overall signal level at the MATRIX A and B outputs.

53. AFL Solo Switch

The AFL switch allows you to hear the Matrix signal through your headphones or monitor outputs. This comes after the MATRIX MASTER, so you can hear the relative signal level of each Matrix output.

When you engage the AFL switch on both MATRIX A and B, the soloed signal appears in stereo in the headphones and monitor outputs. This is useful when you want to use both Matrix outputs to create a stereo mix.

Remember, PFL solo mode always overrides AFL solo mode. If you engage a PFL solo switch on a mono or stereo channel, the AFL solo is disconnected from the headphones and monitor outputs and replaced with the PFL signal. The Rude Solo LEDs below the SOLO meters indicate which solo mode is active.

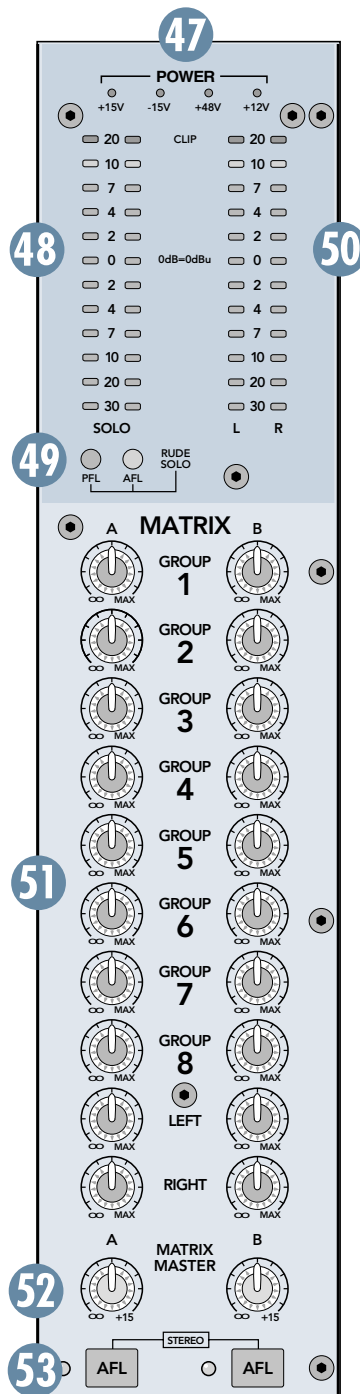

TALKBACK Section, MUTE GROUPS, and MONO OUT

54. MUTE GROUPS MASTER

Remember the four MUTE GROUP [17] switches in each channel strip, just above the channel fader and MUTE switch? Well, these are the master switches used to engage the four mute groups.

When a MUTE GROUP MASTER switch is pushed in, all of the channels assigned to that mute group are muted and their corresponding mute LEDs light. You can engage more than one mute group at a time. If a channel is assigned to two or more mute groups, it remains muted as long as any one of the mute groups it is assigned to is activated.

Mute groups are handy for quickly turning off a number of microphones all at once; for example, all the vocal mics during a break, or all the drum mics...just for fun.

TALKBACK Section

The talkback feature allows the engineer to communicate with the talent either through the AUX 1-8 [72] outputs, GROUPS 1-8 [74] outputs, or the MAIN L/R [79] outputs. In addition, a TALKBACK LINE OUT [77] jack is provided on the rear panel for patching into an external intercom system. Connect an external microphone to the TALKBACK MIC IN XLR [76] connector on the rear panel.

55. TALKBACK LEVEL

Use this knob to control the level of the talkback signal being routed to the AUX, GROUP, or MAIN L/R outputs. This also controls the talkback level for the TALKBACK LINE OUT.

You should start with the TALKBACK LEVEL control turned down, and then slowly turn it up until you get confirmation from whoever is listening to headphones or monitors that they can hear you. Once you have set the level, you can leave it there for the duration of the session (or the gig).

56. TALKBACK DESTINATION Switches

These switches route the talkback signal to various outputs, including AUX 1-2, AUX 3-4, AUX 5-6, AUX 7-8, GROUPS 1-8, and MAIN L/R OUTS. You might use a pair of Aux Sends to communicate with musicians on-stage through their monitors during a live performance. These could be floor wedges or in-ear monitors.

By the way, it is okay to have more than one destination switch pushed in at the same time. The talkback signal will be routed to all the destinations you have selected. But if you don't have any of the destination switches pushed in, the talkback signal won't go to any internal destination (it appears at the TALKBACK OUT jack [77] regardless of the destination switch settings).

57. TALKBACK Switch

This is a latching switch, meaning it's always active when the switch is pushed in. As long as the switch is engaged, the talkback signal is routed to the TALKBACK OUT jack [77] and to the outputs determined by the destination switches [56]. Push the switch again to release it, and the talkback circuit is turned off.

MONO OUT Section

In addition to the Left and Right Main Mix outputs, the Onyx 80 Series provides an independent monophonic output. The Left and Right Main Mix signals are summed and sent to the MONO OUT [78].

58. MONO OUT Level Control

This controls the output level at the MONO OUT.

59. PRE FADER Switch

When this switch is up, the Mono Out signal contains the summed Left and Right Main Mix signal *after* the MAIN MIX faders, so the Mono Output is controlled by both the MAIN MIX faders and the MONO OUT level control.

When this switch is pushed in, the Mono Out signal sums the Left and Right Main Mix signal *before* the MAIN MIX faders, so even if the MAIN MIX faders are turned all the way down, you still get a signal at the MONO OUT.

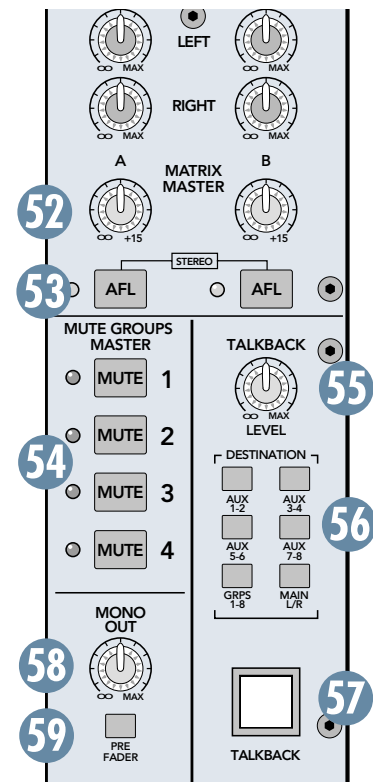

MAIN MIX and PHONES/ MONITOR Section

60. MAIN MIX Faders

These are the master faders that control the levels at the MAIN OUTS.

When MAIN MIX TO MON/PHONES [62] is selected in the PHONES/MONITOR Section, the MAIN MIX fader also controls the main mix level in the PHONES and MONITOR outputs [65/81].

When the faders are fully down, the MAIN MIX is off. The “U” marking indicates unity gain, and fully up provides 10 dB of additional gain. Typically, these faders are set near the “U” label and left alone, but they can be used for song fade-outs or quick system-wide mutes.

61. SOLO LEVEL

The SOLO LEVEL control is used to adjust the volume of the solo’ed signal as it is routed to the MONITOR and PHONES outputs. This control is independent of, and prior to, the MONITOR and PHONES level controls.

This controls the solo signal level for both PFL and AFL solo modes.

62. MAIN TO MON/PHONES Switch

This switch routes the stereo L/R Main Mix signal (post-fader) to both the Monitor and Phones outputs when there are no solo switches engaged. The L/R Main Mix signal is overridden in the Monitor and Phones outputs by any PFL or AFL solo.

Note: If a PFL solo switch is engaged, it overrides the AFL solo mode, including MAIN TO MON/PHONES.

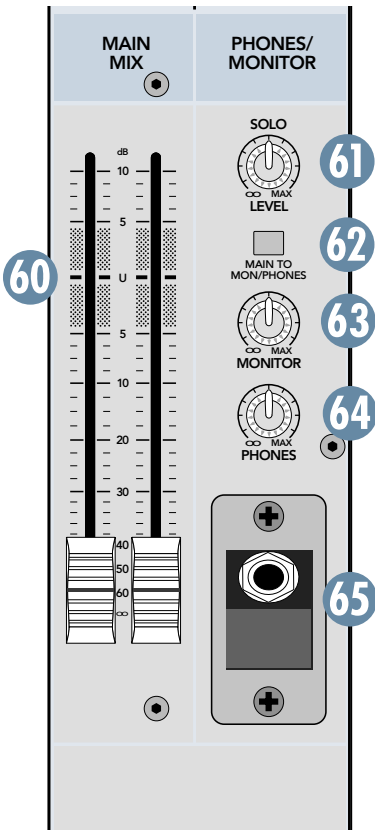

63. MONITOR Level Control

This controls the signal level at both the Left and Right MONITOR OUTS [81].

64. PHONES Level Control

This controls the signal level at the stereo headphone output [65].

65. Headphone Jack

This is where you plug in your stereo headphones. It is a 1/4" TRS stereo jack and provides the same signal that is routed to the MONITOR outputs [81]. The volume is controlled with the PHONES knob [64].

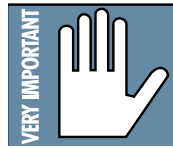

WARNING: The headphone amp is designed to drive any standard headphones to a very loud level. We’re not kidding! It can cause permanent hearing damage. Even intermediate levels may be painfully loud with some headphones. **BE CAREFUL!** Always start with the PHONES level turned all the way down before connecting headphones to the PHONES jack. Keep it down until you’ve put on the headphones. Then turn it up slowly. Why? Always remember: *“Engineers who fry their ears, find themselves with short careers.”*

66. Lamp Connectors

These 4-pin connectors provide +12 volts DC for gooseneck lamps. The Onyx 2480 has two lamp connectors, while the Onyx 3280, 4080, and 4880 all have three lamp connectors. See your Mackie dealer for gooseneck lamp recommendations (12 V lamps with 4-pin XLR-type connectors).

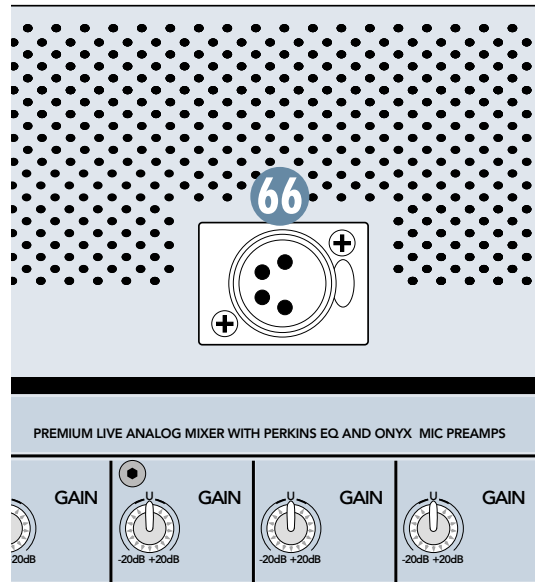

Rear Panel

This is where all the connections are made to the Onyx 80 Series (except the headphones and lamps).

67. MIC Input

This is a female XLR connector, which accepts a balanced microphone input from almost any type of microphone. The microphone preamps feature our new Onyx design, with higher fidelity and headroom rivaling any standalone mic preamp on the market today.

The XLR inputs are wired as follows:

- Pin 1 = Shield or ground
- Pin 2 = Positive (+ or hot)
- Pin 3 = Negative (- or cold)

68. LINE Input

This is a 1/4" TRS connector, which accepts a balanced or unbalanced line-level input signal from almost any source.

When connecting a balanced signal to the LINE inputs, wire them as follows:

- Tip = Positive (+ or hot)
- Ring = Negative (- or cold)
- Sleeve = Shield or ground

When connecting an unbalanced signal, wire them as follows:

- Tip = Positive (+ or hot)
- Sleeve = Shield or ground

69. INSERT

These 1/4" TRS jacks provide a send and return point for each channel. Use the INSERT jacks to connect serial effects devices such as compressors, equalizers, de-essers, or filters to each individual channel.

The INSERT points are after the GAIN, Polarity, and Low Cut controls, but before the EQ and Fader controls. The send (tip) is low-impedance, capable of driving any device. The return (ring) is high-impedance and can be driven by almost any device.

Special insert cables are available, specially designed for this kind of insert jack. They are wired as follows:

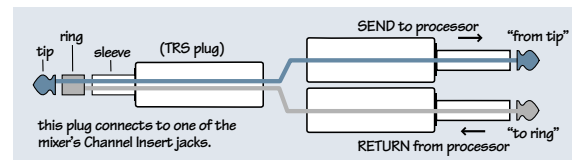

- Tip = Send (output to effects device)
- Ring = Return (input from effects device)
- Sleeve = Common ground (connect shield to all three sleeves)

Besides being used for inserting external devices, these jacks can also be used as channel direct outputs; post-GAIN, post-LOW CUT, and pre-EQ. This is an unbalanced direct out, in contrast to the DIRECT OUTS on the rear panel, which are balanced direct outputs, post-GAIN, post-INSERT, and pre-EQ.

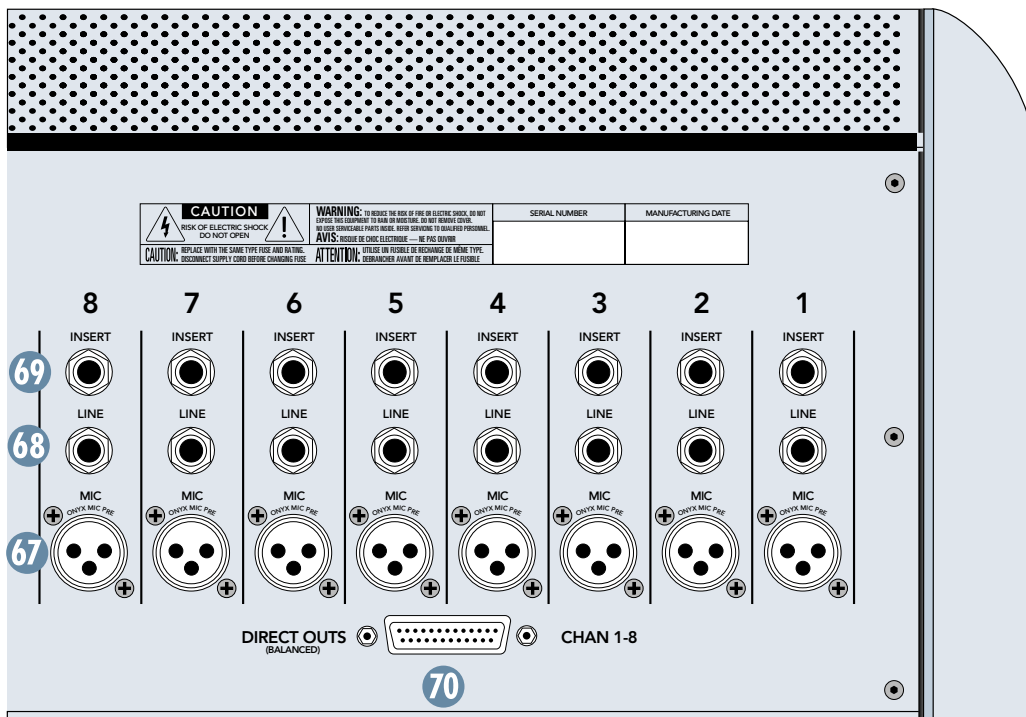

Here are three ways you use the INSERT jacks:

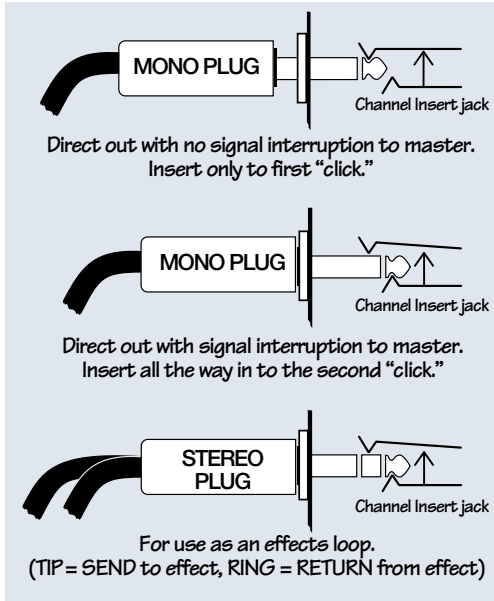

70. DIRECT OUTS

Each of these DB-25 connectors provides balanced direct outputs for eight channels. They are designed to be connected directly to a recorder's analog inputs, and use the TASCAM standard pinout for analog signal connections (the same standard used on the analog cards for the Mackie D8B and Hard Disk Recorder).

The signal at the DIRECT OUTS comes after the input GAIN control, Polarity switch, Low-Cut switch, and INSERT jack, but before the EQ. This way you can EQ a channel and adjust the channel fader to suit your live mix, but it has no effect on the signal going to the recorder. This provides maximum flexibility for the mixdown stage.

Internal jumpers are provided to change the DIRECT OUTS to post-EQ on a channel-by-channel basis, if desired. This requires some soldering skills, so contact Tech Support for information on how to access the pre/post-EQ jumpers for the DIRECT OUTS.

See Appendix B for a wiring diagram of the DIRECT OUT connectors.

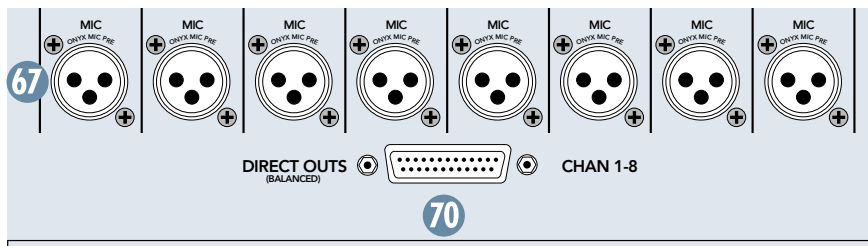

71. STEREO AUX INPUTS 1-8

These 1/4" TRS input connectors accept balanced or unbalanced line-level stereo signals from an external processor or other line-level device. The stereo AUX INPUTS use a technique called jack normaling. If a signal is plugged into the LEFT (MONO) side and nothing is plugged into the RIGHT side, the signal is automatically connected to both LEFT and RIGHT sides. As soon as something is plugged into the RIGHT side, the normalled connection is broken and the LEFT and RIGHT inputs become stereo inputs (LEFT goes to the LEFT MAIN OUT and RIGHT goes to the RIGHT MAIN OUT).

72. AUX SENDS 1-8

These 1/4" TRS output connectors provide balanced or unbalanced line-level signals for connecting to the inputs of effects devices or stage monitor amplifiers.

73. AUX SEND INSERTS

These 1/4" TRS jacks are for connecting serial effects such as compressors, equalizers, deessers, or filters. The insert point is after the mix amps, but before the Aux Send Masters (and before the GROUP/AUX FLIP switch, so the insert point only affects the Aux Send signal). Refer to the description of the channel insert on page 21 to see how to make this connection.

74. GROUP SENDS 1-8

These 1/4" TRS output connectors provide balanced or unbalanced line-level signals for connecting to the inputs of any line-level device.

75. GROUP SEND INSERTS

These 1/4" TRS jacks are for connecting serial effects such as compressors, equalizers, deessers, or filters. The insert point is after the mix amps, but before the Group Send Masters (and before the GROUP/AUX FLIP switch, so the insert point only affects the Group Send signal). Refer to the description of the channel insert on page 21 to see how to make this connection.

76. TALKBACK MIC IN

This is where you plug in your external talkback microphone. This female XLR connector does not have phantom power, so use a dynamic microphone or a self-powered condenser microphone.

77. TALKBACK LINE OUT

This 1/4" TRS output connector provides a balanced or unbalanced line-level signal for connecting to the input of an external intercom system or other line-level device.

78. MONO OUT

This male XLR output connector provides a balanced line-level signal that is a combination of the left and right MAIN OUT signals (L+R). You can use this for a separate mix that doesn't require a stereo feed, or to simply test the monaural compatibility of your stereo mix.

79. LEFT/RIGHT MAIN OUTS

There are two sets of outputs for the Left/Right Main Outputs: Male XLR connectors that provide balanced line-level signals and 1/4" TRS connectors that provide balanced or unbalanced line-level signals. Each XLR connector is in parallel with its corresponding 1/4" TRS connector, and carries exactly the same signal.

This represents the end of the mixer chain, where your fully mixed stereo signal enters the real world. Connect these to the inputs of your main power amplifiers, powered speakers, or serial effects processor (like a graphic equalizer or compressor/limiter).

80. MAIN INSERT

These 1/4" TRS jacks are for connecting serial effects such as compressors, equalizers, deessers, or filters. The insert point is after the mix amps, but before the MAIN MIX faders. Refer to the description of the channel insert on page 21 to see how to make this connection.

81. MONITOR OUT

These 1/4" TRS jacks provide a balanced line-level signal that can be used to provide another main mix output (with MAIN MIX TO MON/PHONES selected in the PHONES/MONITOR Section), or to monitor soloed channels.

Connect these outputs to the inputs of an amplifier, powered speaker, headphone distribution amplifier, or recording device.

82. MATRIX OUT

These 1/4" TRS jacks provide balanced line-level signals for the MATRIX A and B mixes. These can be connected to the inputs of an amplifier, powered speaker, headphone distribution amplifier, or recording device.

83. REDUNDANT POWER SUPPLY Connector

This is where you connect the optional Onyx PS External Redundant Power Supply. Normally, the Onyx 80 Series operates on its built-in universal power supply. With the Onyx PS connected, in the unlikely event that the internal power supply should fail, the external supply will seamlessly take over powering the Onyx 80 Series mixing console.

This provides an extra measure of insurance that the show will go on.

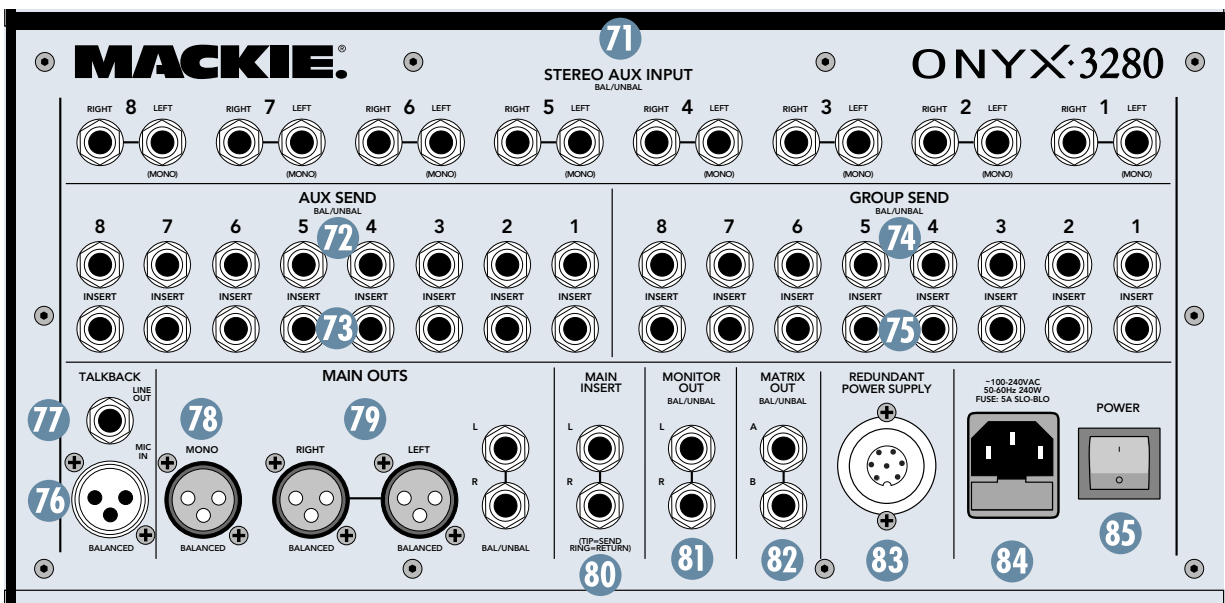

84. Power Receptacle

This is a standard 3-prong IEC power connector. Connect the detachable linecord (included in the box with your Onyx 80 Series) to the power receptacle, and plug the other end of the linecord into an AC outlet. The Onyx 80 Series has a universal power supply that can accept any AC voltage ranging from 100 VAC to 240 VAC. No need for voltage select switches. It will work virtually anywhere in the world. That's why we call it a "Planet-Earth" power supply! This also means that it is less susceptible to voltage sags or spikes, providing greater electromagnetic isolation and better protection against AC line noise.

85. POWER Switch

This one is self-explanatory. When the POWER switch is turned ON, power is supplied to the Onyx 80 Series and the four POWER LEDs on the front panel light up.

Note: If the external Redundant Power Supply is connected and turned on, the unit will power up regardless of the setting of this switch.

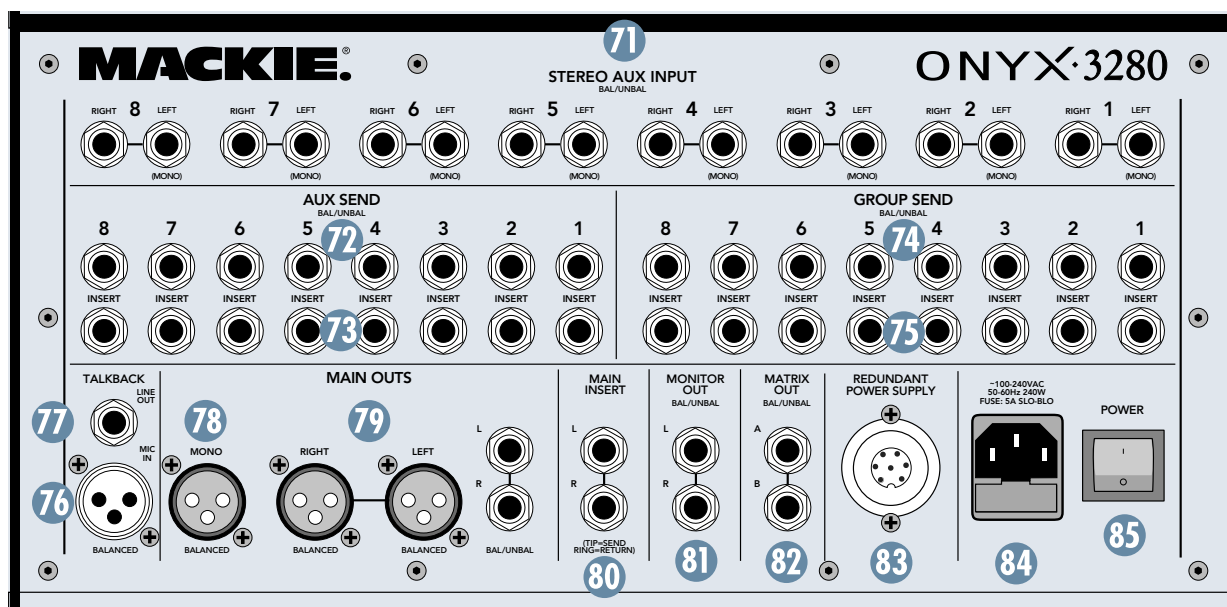

Appendix A: Service Information

Warranty Service

Details concerning Warranty Service are spelled out in the Warranty section on page 35.

If you think your Onyx mixer has a problem, please do everything you can to confirm it before calling for service. Doing so might save you from the deprivation of your Onyx mixer and the associated suffering.

These may sound obvious to you, but here are some things you can check. Read on.

Troubleshooting

No Power

- Our favorite question: Is it plugged in?
- Make sure the power cord is securely seated in the IEC socket [84] and plugged all the way into the AC outlet.
- Make sure the AC outlet is live (check with a tester or lamp).
- Is the POWER [85] switch on? Make sure the POWER switch on the rear panel is in the ON position (up).
- Are the POWER LEDs [47] on the front panel illuminated? If not, make sure the AC outlet is live.
- Are all the lights out in your building? If so, contact your local power company to get power restored.
- If the POWER LEDs are not illuminated, and you are certain that the AC outlet is live, it will be necessary to have your Onyx 80 Series serviced. *There are no user serviceable parts inside.* Refer to “Repair” at the end of this section to find out how to proceed.
- If you have an external Redundant Power Supply, try using it to power the Onyx 80 Series. It is possible to operate the Onyx 80 Series in this way, even if the internal supply has failed.

Bad Channel

- Is the MUTE button [18] pushed in?
- Is the input GAIN control [5] for the channel turned up?
- Is the fader [19] turned up?
- Is the signal source turned up? Make sure the signal level from the selected input source is high enough to light up some of the INPUT meter [20] LEDs next to the channel's fader.

- Is the channel assigned to a bus (GROUP ASSIGN or MAIN MIX button pushed in)?
- Is there something plugged into the CHANNEL INSERT jack [63]? Try unplugging any INSERT devices.
- Try the same source signal in another channel, set up exactly like the suspect channel.

Bad Output

- Is the associated level control (if any) turned up?
- If it's one of the MAIN OUTPUTS, try unplugging all the others. For example, if it's the 1/4" LEFT MAIN OUT, unplug the XLR LEFT OUTPUT. If the problem goes away, it's not the mixer.
- If it's a stereo pair, try switching them around. For example, if a left output is presumed dead, switch the left and right cords at the mixer end. If the problem stays on the left side, it's not the mixer.

Bad Sound

- Is the input connector plugged completely into the jack?
- Is it loud and distorted? Make sure the input GAIN control for the input is set correctly. Reduce the signal level on the input source if possible.
- If possible, listen to the signal with headphones plugged into the input source device. If it sounds bad there, it's not the Onyx 80 Series causing the problem.

Noise/Hum

- Turn down the AUX INPUT faders [33]. If the noise disappears, it's coming from whatever is plugged into the AUX INPUTS [71].
- Turn down each channel, one by one. If the noise disappears, it's coming from whatever is plugged into that channel.
- Check the signal cables between the input sources and the Onyx. Disconnect them one by one. When the noise goes away, you'll know which input source is causing the problem.
- Sometimes it helps to plug all the audio equipment into the same AC circuit so they share a common ground.

Repair

Service for Mackie products is available at a factory-authorized service center. Service for Mackie products living outside the United States can be obtained through local dealers or distributors.

If your Onyx 80 Series needs service, follow these instructions:

1. Review the preceding troubleshooting suggestions. Please.
2. Call Tech Support at 1-800-898-3211, 7 am to 5 pm PST, to explain the problem and obtain a Service Request Number. Have your Onyx 80 Series' serial number ready. ***You must have a Service Request Number before you can obtain service at the factory.***
3. Keep this owner's manual and the detachable line-cord. We don't need them to repair the mixer.
4. Pack the mixer in its original package, including endcaps and box. This is ***VERY IMPORTANT***. *Mackie is not responsible for any damage that occurs due to non-factory packaging.*
5. Include a legible note stating your name, shipping address (no P.O. boxes), daytime phone number, Service Request Number, and a detailed description of the problem, including how we can duplicate it.
6. Write the Service Request Number in **BIG PRINT** on top of the box. Units sent to us without the Service Request Number will be refused.
7. Tech Support will tell you where to ship the mixer for repair. We suggest insurance for all forms of cartage.
8. We'll try to fix the mixer within three to five business days. Ask Tech Support for the latest turn-around times when you call for your Service Request Number. The mixer must be packaged in its original packing box, and must have the Service Request Number on the box. Once it's repaired, we'll ship it back the same way in which it was received. This paragraph does not necessarily apply to non-warranty repair.

Note: You must have a sales receipt from an Authorized Mackie Dealer to qualify for a warranty repair.

Need Help?

**You can reach a technical support representative
Monday through Friday
from 7 AM to 5 PM PST at:**

1-800-898-3211

**After hours, visit www.mackie.com and click Support,
or email us at: techmail@mackie.com**



Appendix B: Connections

XLR Connectors

The mono channels use 3-pin female XLR connectors on the MIC inputs. They are wired as follows, according to standards specified by the AES (Audio Engineering Society).

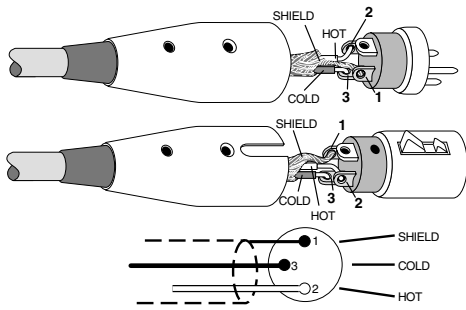

XLR Balanced Wiring:
 Pin 1 = Shield
 Pin 2 = Hot (+)
 Pin 3 = Cold (-)

1/4" TRS Phone Plugs and Jacks

"TRS" stands for Tip-Ring-Sleeve, the three connection points available on a stereo 1/4" or balanced phone jack or plug. TRS jacks and plugs are used for balanced signals and stereo headphones:

Balanced Mono

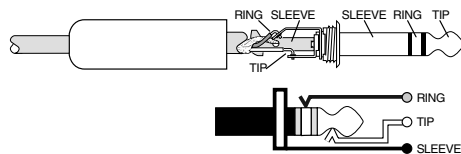

1/4" TRS Balanced Mono Wiring:
 Sleeve = Shield
 Tip = Hot (+)
 Ring = Cold (-)

Stereo Headphones

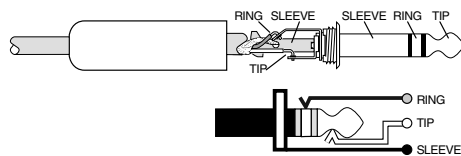

1/4" TRS Stereo Unbalanced Wiring:
 Sleeve = Shield
 Tip = Left
 Ring = Right

1/4" TS Phone Plugs and Jacks

"TS" stands for Tip-Sleeve, the two connection points available on a mono 1/4" phone jack or plug. They are used for unbalanced signals.

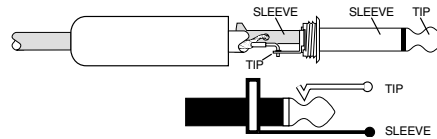

1/4" TS Unbalanced Wiring:
 Sleeve = Shield
 Tip = Hot (+)

RCA Plugs and Jacks

RCA-type plugs (also known as phono plugs) and jacks are often used in home stereo and video equipment and in many other applications. They are unbalanced and electrically equivalent to a 1/4" TS phone plug.

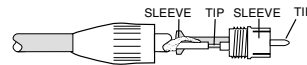

RCA Unbalanced Wiring:
 Sleeve = Shield
 Tip = Hot (+)

Unbalancing a Line

In most studio, stage, and sound reinforcement situations, there is a combination of balanced and unbalanced inputs and outputs on the various pieces of equipment. This usually will not be a problem in making connections.

- When connecting a balanced output to an unbalanced input, be sure the signal high (hot) connections are wired to each other, and that the balanced signal low (cold) goes to the ground (earth) connection at the unbalanced input. In most cases, the balanced ground (earth) will also be connected to the ground (earth) at the unbalanced input. If there are ground-loop problems, this connection may be left disconnected at the balanced end.

- When connecting an unbalanced output to a balanced input, be sure that the signal high (hot) connections are wired to each other. The unbalanced ground (earth) connection should be wired to the low (cold) and the ground (earth) connections of the balanced input. If there are ground-loop problems, try disconnecting the unbalanced ground (earth) connection from the balanced input ground (earth) connection, leaving the unbalanced ground connected to the balanced input low (cold) connection only.

In some cases, you may have to make up special adapters to interconnect your equipment. For example, you may need a balanced XLR female connected to an unbalanced 1/4" TS phone plug. Many common adapters can be found at your local electronics supply store.

The balanced-to-unbalanced connection has been anticipated in the wiring of Mackie jacks. A 1/4" TS plug inserted into a 1/4" TRS balanced input, for example, will automatically unbalance the input and make all the right connections. Conversely, a 1/4" TRS plug inserted into a 1/4" unbalanced input will not necessarily tie the ring (low or cold) to ground (earth).

TRS Send/Receive Insert Jacks

Mackie's single-jack inserts are three-conductor 1/4" TRS phone jacks. They are unbalanced, but have both the mixer output (send) and mixer input (return) signals in one connector.

The sleeve is the common ground (earth) for both signals. The send from the mixer to the external unit is carried on the tip, and the return from the unit to the mixer is on the ring.

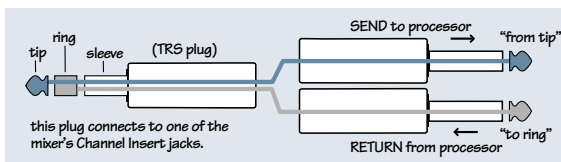

Using the Send Only on an Insert Jack

If you insert a 1/4" TS (mono) plug only partially (to the first click) into a Mackie insert jack, the plug will not activate the jack switch and will not open the insert loop in the circuit (thereby allowing the channel signal to continue on its merry way through the mixer).

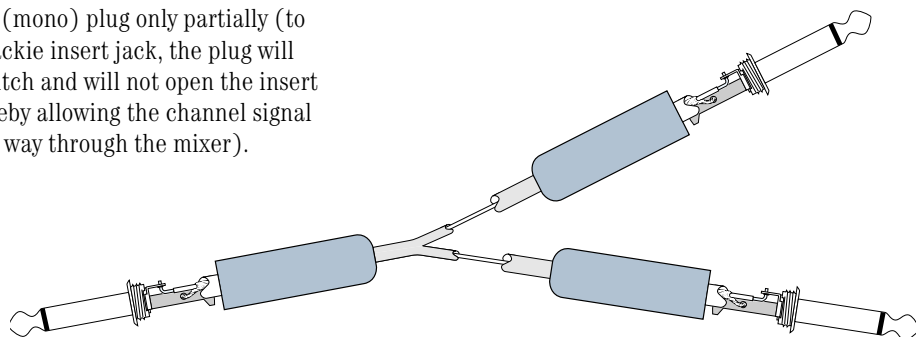

Y-Cord Splitter

This allows you to tap out the channel's signal at that point in the circuit without interrupting normal operation.



Note: Do not overload or short-circuit the signal you are tapping from the mixer. That will affect the internal signal.

If you push the 1/4" TS plug in to the second click, you will open the jack switch and create a direct out, which does interrupt the signal in that channel.

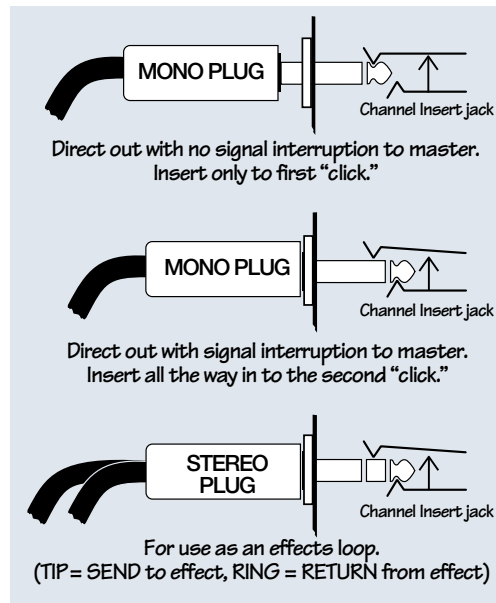

Mults and "Y"s

A mult or "Y" connector allows you to route one output to two or more inputs by simply providing parallel wiring connections. You can make "Y"s and mults for the outputs of both unbalanced and balanced circuits.



Remember: Only mult or "Y" an output into several inputs. If you need to combine several outputs into one input, you must use a mixer, not a mult or a "Y."

DB25 Connectors

The DIRECT OUTS on the back of the Onyx 80 Series provide balanced direct outputs for all the mono channels on female DB25 connectors. These connectors are pin-for-pin compatible with the analog (not TDIF) DB25 connectors found on TASCAM DTRS recorders, which has become an industry standard for many professional audio manufacturers. They are also the same pinout as the analog cards for the Mackie D8B and hard disk recorders.

	Signal Description	DIRECT OUTS 1-8		Signal Description	DIRECT OUTS 1-8
Pin 1	+	Ch 8	Pin 14	-	Ch 8
Pin 2	shield	Ch 8	Pin 15	+	Ch 7
Pin 3	-	Ch 7	Pin 16	shield	Ch 7
Pin 4	+	Ch 6	Pin 17	-	Ch 6
Pin 5	shield	Ch 6	Pin 18	+	Ch 5
Pin 6	-	Ch 5	Pin 19	shield	Ch 5
Pin 7	+	Ch 4	Pin 20	-	Ch 4
Pin 8	shield	Ch 4	Pin 21	+	Ch 3
Pin 9	-	Ch 3	Pin 22	shield	Ch 3
Pin 10	+	Ch 2	Pin 23	-	Ch 2
Pin 11	shield	Ch 2	Pin 24	+	Ch 1
Pin 12	-	Ch 1	Pin 25	shield	Ch 1
Pin 13	N/C	---			

CH 1 CH 2 CH 3 CH 4 CH 5 CH 6 CH 7 CH 8
 CH 9 CH 10 CH 11 CH 12 CH 13 CH 14 CH 15 CH 16
 CH 17 CH 18 CH 19 CH 20 CH 21 CH 22 CH 23 CH 24
 CH 25 CH 26 CH 27 CH 28 CH 29 CH 30 CH 31 CH 32
 CH 33 CH 34 CH 35 CH 36 CH 37 CH 38 CH 39 CH 40
 CH 41 CH 42 CH 43 CH 44 CH 45 CH 46 CH 47 CH 48

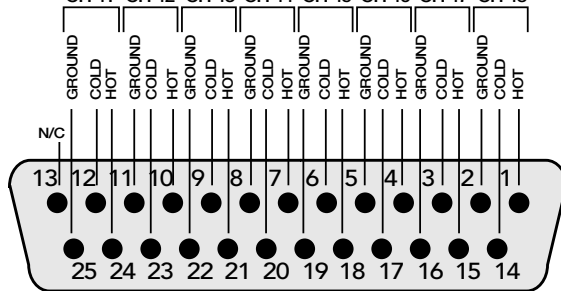

Several companies make DB25-to-DB25 cables specifically for audio, with proper shielding to reduce crosstalk and noise.

DB25 cables that break out to XLR, 1/4" TRS, or TT connectors for connecting to other mixers or audio gear are also readily available. See your Mackie dealer for details.



Appendix C: Technical Info

Onyx 80 Series Specifications

Frequency Response

Mic Input to Main Output (Gain @ Unity)
 +0, -1 dB, <10 Hz to 80 kHz
 +0, -3 dB, <10 Hz to 130 kHz

Distortion (THD & IMD)

Mic Input to Main Output (@ +4 dBu)
 THD: < 0.007% max, 0.005% typical, 20 Hz to 20 kHz
 SMPTE IMD: < 0.005% (7 kHz/60 Hz, 4:1)

Dynamic Range

>105 dB, 24 channels assigned
 >115 dB, one-channel assigned

Noise Floor

Signal-to-Noise Ratio:
 -87 dBu (ref. +4 dBu, Mic In to Main Out,
 48 channels and Main Mix levels at unity)
 -90 dBu, (ref. +4 dBu, Mic In to Main Out,
 24 channels and Main Mix levels at unity)
 Equivalent Input Noise (E.I.N.), 20 Hz to 20 kHz Bandwidth,
 150Ω source impedance
 -129.5 dBu @ +60 dB gain
 Mic Output Noise:
 Direct Output: -98 dBu (minimum gain)
 Residual Output Noise:
 Main Out: -100 dBu (Channel and Main Mix levels off)
 Main Out: -83 dBu (48 channels and Main Mix levels
 at unity)
 -86 dBu (24 channels and Main Mix levels
 at unity)

Common Mode Rejection Ratio (CMRR)

Mic In: >70 dB @ 1 kHz, Gain @ maximum

Crosstalk

Adjacent Inputs: < -95 dB @ 1 kHz
 Input to Output: < -85 dB @ 1 kHz

Input Gain Control Range

Mic In: 0 dB to +60 dB
 Line In: -20 dB to +40 dB, mono channels

Phantom Power

+48 VDC

Equalization

Mono Channel EQ:
 High: ±15 dB @ 12 kHz
 High Mid: ±15 dB, sweepable from 400 Hz to 8 kHz
 Low Mid: ±15 dB, sweepable from 100 Hz to 2 kHz
 Low: ±15 dB @ 80 Hz
 Stereo Channel (Aux Input) EQ:
 High: ±15 dB @ 12 kHz
 High Mid: ±15 dB @ 2.5 kHz
 Low Mid: ±15 dB @ 400 Hz
 Low: ±15 dB @ 80 Hz

Mixer Rated Output

Main Outs: +4 dBu
 Aux Send: +4 dBu
 Group Send: +4 dBu
 Monitor Out: +4 dBu
 Matrix Out: +4 dBu
 Maximum Rated Output:
 +21 dBu @ Main XLR and TRS outputs

Maximum Input Levels

Mic Input: +21 dBu, Gain @ unity
 Line Input: +30 dBu, Gain @ -20 dB
 Aux Input: +21 dBu

Maximum Voltage Gain

Mic Input to:
 Main Out: 90 dB
 Group Send: 80 dB
 Aux Sends: 86 dB
 Monitor Out: 102 dB
 Matrix Out: 105 dB
 Phones Out: 102 dB
 Line Input to:
 Main Out: 70 dB
 Group Send: 60 dB
 Aux Sends: 66 dB
 Monitor Out: 82 dB
 Matrix Out: 85 dB
 Phones Out: 82 dB
 Stereo Aux Input to:
 Main Out: 50 dB
 Group Send: 40 dB
 Aux Sends: 39 dB
 Monitor Out: 62 dB
 Matrix Out: 65 dB
 Phones Out: 62 dB

Input Impedance

Mic Input: 2.4 kΩ, balanced
 Mono Channel Line Input: 30 kΩ balanced;
 15 kΩ unbalanced
 Stereo Aux Inputs: 20 kΩ balanced;
 20 kΩ unbalanced

Output Impedance

Main Out: 150 Ω balanced, XLR outputs;
 150 Ω TRS outputs
 Direct Out: 300 Ω
 Group Sends: 100 Ω
 Monitor Out: 100 Ω
 Matrix Out: 100 Ω
 Aux Sends: 100 Ω
 Phones Out: 25 Ω

Channel Level LED (Sensitivity)

0 LED = 0 dBu (normal operating level)

VU Meters

Main and Solo Left and Right, 12 segments:

Clip (+20), +10, +7, +4, +2, 0, -2, -4, -7, -10, -20, -30

0 LED = 0 dBu

AC Power Requirements

Power Consumption:

Onyx 2480	180 watts
Onyx 3280	200 watts
Onyx 4080	220 watts
Onyx 4880	240 watts

Universal AC Power Supply:

100 VAC – 240 VAC, 50-60 Hz

Physical Dimensions and Weight**Onyx 2480**

Height:	9.4 in/239 mm
Width:	48.8 in/1240 mm
Depth:	29.6 in/751 mm
Weight:	95 lb/43 kg

Onyx 3280

Height:	9.4 in/239 mm
Width:	60.0 in/1523 mm
Depth:	29.6 in/751 mm
Weight:	113 lb/51 kg

Onyx 4080

Height:	9.4 in/239 mm
Width:	70.4 in/1788 mm
Depth:	29.6 in/751 mm
Weight:	131 lb/59 kg

Onyx 4880

Height:	9.4 in/239 mm
Width:	81.3 in/2065 mm
Depth:	29.6 in/751 mm
Weight:	149 lb/68 kg

Options

Onyx PS External Redundant Power Supply

LOUD Technologies Inc. is always striving to improve our products by incorporating new and improved materials, components, and manufacturing methods. Therefore, we reserve the right to change these specifications at any time without notice.

“Mackie.,” “Onyx,” and the “Running Man” are registered trademarks of LOUD Technologies Inc. All other brand names mentioned are trademarks or registered trademarks of their respective holders, and are hereby acknowledged.

©2005 LOUD Technologies Inc. All Rights Reserved.

Onyx 80 Series Dimensions

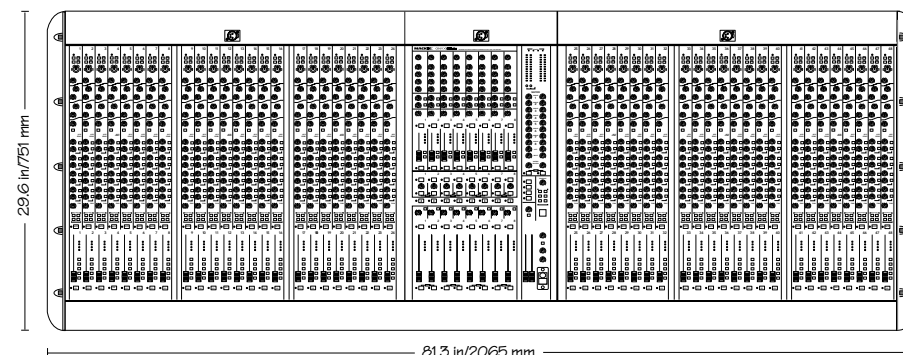
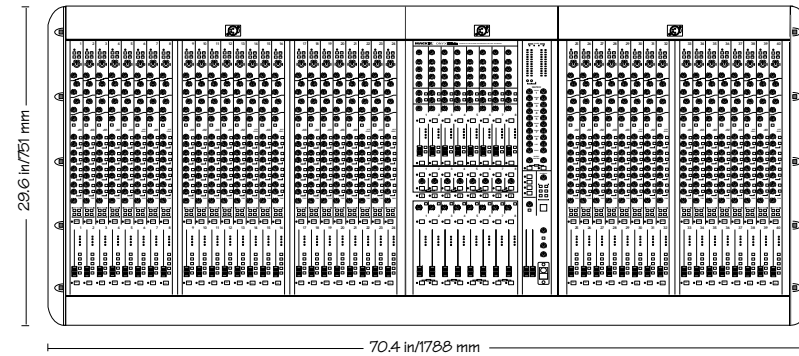
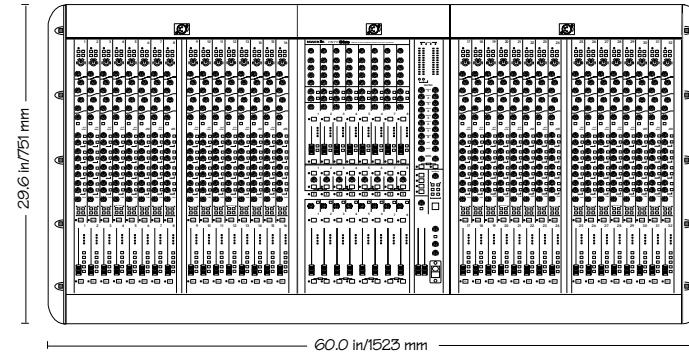
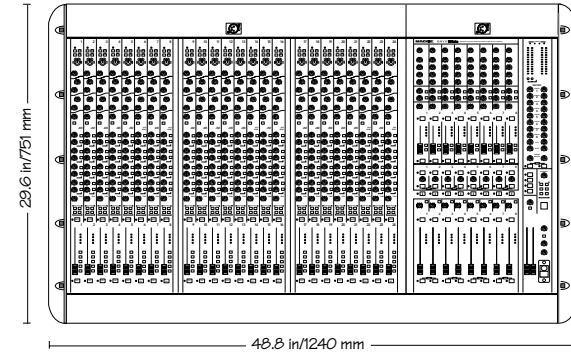
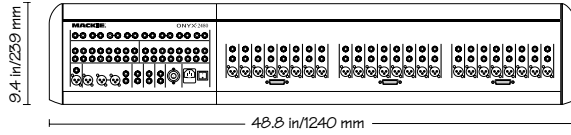

Onyx 80 Series Block Diagram

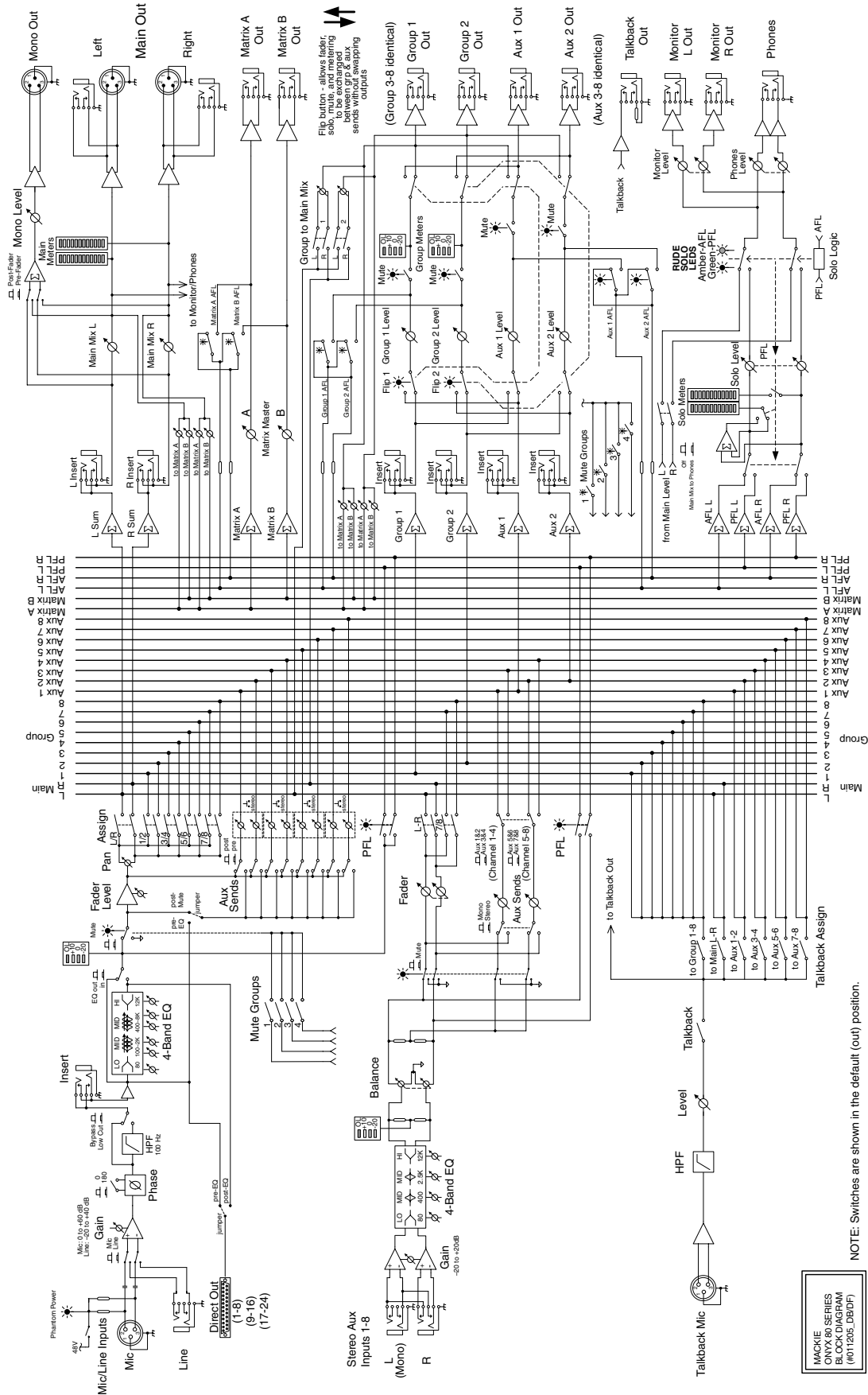

NOTE: Switches are shown in the default (out) position.

MACKIE
ONYX 80 SERIES
BLOCK DIAGRAM
(#01205_DBDf)

Onyx 80 Series Gain Structure Diagram

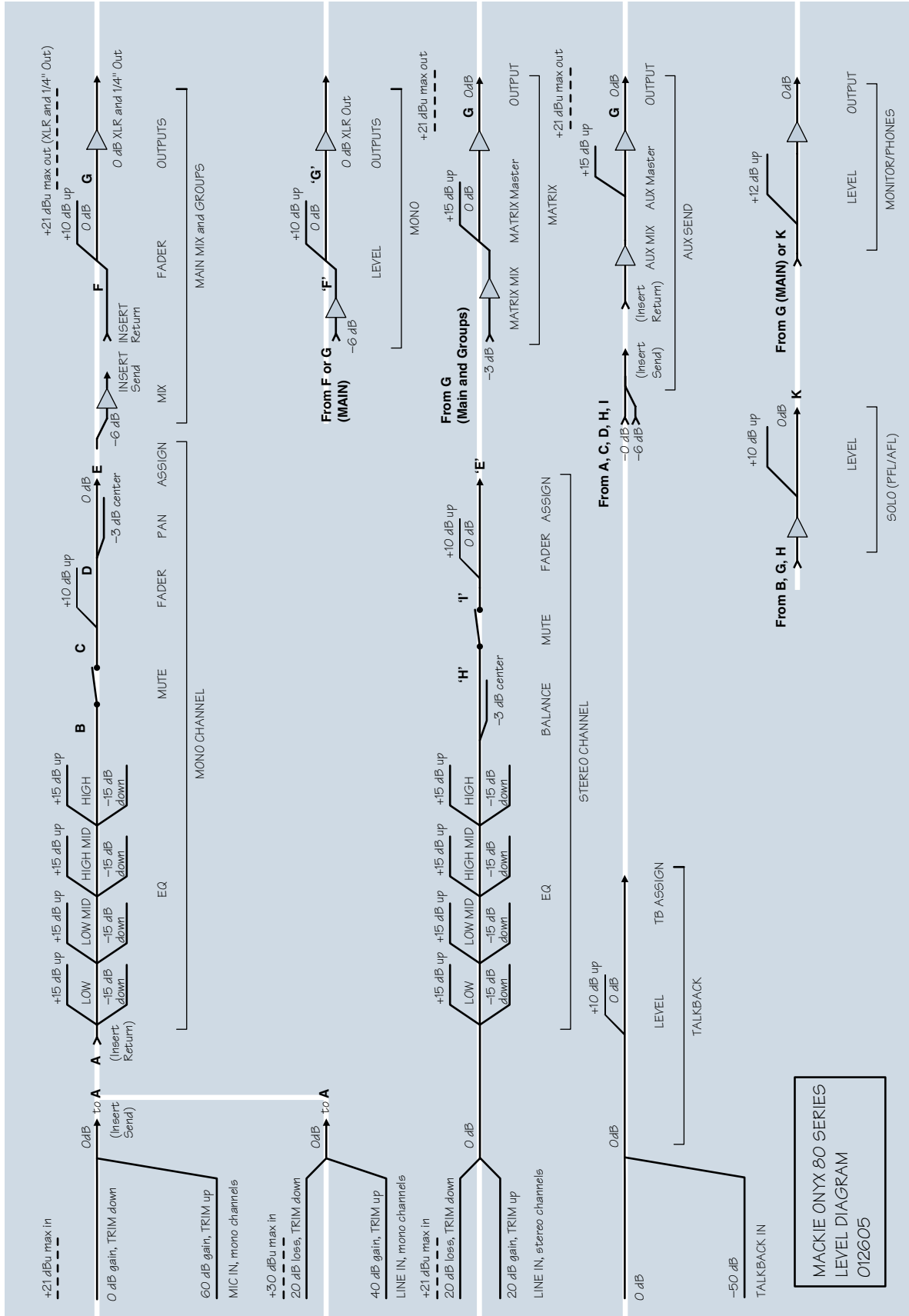

MACKIE ONYX 80 SERIES
LEVEL DIAGRAM
012605

Onyx 80 Series Limited Warranty

Please keep your sales receipt in a safe place.

A. LOUD Technologies Inc. warrants all materials, workmanship and proper operation of this product for a period of **three years** from the original date of purchase. If any defects are found in the materials or workmanship or if the product fails to function properly during the applicable warranty period, LOUD Technologies, at its option, will repair or replace the product. **This warranty applies only to equipment sold and delivered within the U.S. by LOUD Technologies Inc. or its authorized dealers.**

B. Failure to register online or return the product registration card will not void the three-year warranty.

C. Service and repairs of Mackie products are to be performed **only** at a factory-authorized facility (see D below). Unauthorized service, repairs, or modification will void this warranty. To obtain repairs under warranty, you must have a copy of your sales receipt from the authorized Mackie dealer where you purchased the product. It is necessary to establish purchase date and determine whether your Mackie product is within the warranty period.

D. To obtain factory-authorized service:

1. Call Mackie Technical Support at 800/898-3211, 7 AM to 5 PM Monday through Friday (Pacific Time) to get a Service Request Number. Products returned without a Service Request Number will be refused.

2. Pack the product in its original shipping carton. Also include a note explaining exactly how to duplicate the problem, a copy of the sales receipt with price and date showing, and your return street address (no P.O. boxes or route numbers, please!). If we cannot duplicate the problem or establish the starting date of your Limited Warranty, we may, at our option, charge for service time.

3. Ship the product in its original shipping carton, **freight prepaid** to the authorized service center. The address of your closest authorized service center will be given to you by Technical Support.

IMPORTANT: Make sure that the Service Request Number is plainly written on the shipping carton.

E. LOUD Technologies reserves the right to inspect any products that may be the subject of any warranty claims before repair or replacement is carried out. LOUD Technologies may, at our option, require proof of the original date of purchase in the form of a dated copy of the original dealer's invoice or sales receipt. Final determination of warranty coverage lies solely with LOUD Technologies.

F. Any products returned to one of the LOUD Technologies factory-authorized service centers and deemed eligible for repair or replacement under the terms of this warranty will be repaired or replaced within thirty days of receipt. LOUD Technologies and its authorized service centers may use refurbished parts for repair or replacement of any product. Products returned to LOUD Technologies that do not meet the terms of this Warranty will be not be repaired unless payment is received for labor, materials, return freight, and insurance. Products repaired under warranty will be returned freight prepaid by LOUD Technologies to any location within the boundaries of the USA.

G. LOUD Technologies warrants all repairs performed for 90 days or for the remainder of the warranty period. This warranty does not extend to damage resulting from improper installation, misuse, neglect or abuse, or to exterior appearance. This warranty is recognized only if the inspection seals and serial number on the unit have not been defaced or removed.

H. LOUD Technologies assumes no responsibility for the quality or timeliness of repairs performed by an authorized service center.

I. This warranty is extended to the original purchaser and to anyone who may subsequently purchase this product within the applicable warranty period. A copy of the original sales receipt is required to obtain warranty repairs.

J. This is your sole warranty. LOUD Technologies does not authorize any third party, including any dealer or sales representative, to assume any liability on behalf of LOUD Technologies or to make any warranty for LOUD Technologies Inc.

K. THE WARRANTY GIVEN ON THIS PAGE IS THE SOLE WARRANTY GIVEN BY LOUD TECHNOLOGIES INC. AND IS IN LIEU OF ALL OTHER WARRANTIES, EXPRESS AND IMPLIED, INCLUDING THE WARRANTIES OF MERCHANTABILITY AND FITNESS FOR A PARTICULAR PURPOSE. THE WARRANTY GIVEN ON THIS PAGE SHALL BE STRICTLY LIMITED IN DURATION TO THREE YEARS FROM THE DATE OF ORIGINAL PURCHASE FROM AN AUTHORIZED MACKIE DEALER. UPON EXPIRATION OF THE APPLICABLE WARRANTY PERIOD, LOUD TECHNOLOGIES INC. SHALL HAVE NO FURTHER WARRANTY OBLIGATION OF ANY KIND. LOUD TECHNOLOGIES INC. SHALL NOT BE LIABLE FOR ANY INCIDENTAL, SPECIAL, OR CONSEQUENTIAL DAMAGES THAT MAY RESULT FROM ANY DEFECT IN THE MACKIE PRODUCT OR ANY WARRANTY CLAIM. Some states do not allow exclusion or limitation of incidental, special, or consequential damages or a limitation on how long warranties last, so some of the above limitations and exclusions may not apply to you. This warranty provides specific legal rights and you may have other rights which vary from state to state.

MACKIE®

16220 Wood-Red Road NE • Woodinville, WA 98072 • USA

United States and Canada: 800.898.3211

Europe, Asia, Central and South America: 425.487.4333

Middle East and Africa: 31.20.654.4000

Fax: 425.487.4337 • www.mackie.com

E-mail: sales@mackie.com