

Major Options

Optional Lenses	Short Fixed Lens	Short Zoom Lens	Short Zoom Lens	Standard Zoom Lens	Long Zoom Lens	Long Zoom Lens	
Part Number	LNS-W52	LNS-W51	LNS-W50	LNS-S50	LNS-T50	LNS-T51	
Image							
Zoom/ Focus	Fixed / motorised	x1.25 / motorised	x1.2 / motorised	x1.56 / motorised	x1.8 / motorised	x1.67 / motorised	
Screen Size (")	50-200	50-600	50-600	50-600	50-600	50-600	
Throw Ratio	DHT100L DET100L	0.8:1 0.87:1	1.2-1.5:1 1.3-1.63:1	1.6-1.8:1 1.62-1.95:1	1.8-2.8:1 1.95-3.08:1	2.8-5.0:1 3.03-5.50:1	4.8-8.0:1 5.21-8.63:1
F Value	2.0	2.3-2.7	2.0-2.1	2.0-2.6	2.0-2.9	2.3-3.2	
Net Weight (Unit: kg (lb))	3.1 (6.8)	4.1 (9.0)	3.3 (7.3)	3.4 (7.5)	3.7 (8.2)	3.8 (8.4)	
Lens Shift (DHT100L) (approx)	H1:H2 W1:W2	1:1	6.65:-1 -1:6.65	6.65:-1 -1:6.65	6.65:-1 -1:6.65	6.65:-1 -1:6.65	
Lens Shift (DET100L) (approx)	H1:H2 W1:W2	1:1	10.7:1 - 1:10.7	10.7:1 - 1:10.7	10.7:1 - 1:10.7	10.7:1 - 1:10.7	
Lens Shift (DHT100L) (approx)	H1:H2 W1:W2	1:1	21:-1 -1:21	21:-1 -1:21	21:-1 -1:21	21:-1 -1:21	
Lens Shift (DET100L) (approx)	H1:H2 W1:W2	1:1	9:1 - 1:9	19:1 - 1:19	19:1 - 1:19	19:1 - 1:19	

PDG-DHT100L / PDG-DHT100WL Throw distance (Unit: m (ft)) Aspect Ratio 16:9

Part Number	LNS-W52	LNS-W51	LNS-W50	LNS-S50	LNS-T50	LNS-T51
	Fixed	Wide	Tele	Wide	Tele	Wide
50"	0.86(2.81)	1.3(4.2)	1.6(5.3)	1.6(5.3)	2.0(6.4)	2.4(7.7)
60"	1.04(3.41)	1.5(5.1)	2.0(6.4)	1.9(6.4)	2.4(7.7)	3.1(10.2)
70"	1.22(4.01)	1.8(6.0)	2.3(7.5)	2.3(7.5)	2.8(9.1)	3.7(12.3)
80"	1.41(4.61)	2.1(6.9)	2.7(8.7)	2.6(8.5)	3.2(10.4)	4.3(14.1)
100"	1.77(5.82)	2.7(8.7)	3.3(11.0)	3.3(11.0)	4.0(13.1)	5.0(16.5)
150"	2.69(8.82)	4.0(13.2)	5.1(16.6)	5.0(16.4)	6.0(19.8)	7.8(25.6)
200"	3.60(11.83)	5.4(17.8)	6.8(22.3)	6.7(22.0)	8.1(26.6)	10.7(35.0)
250"	-	6.8(22.3)	8.5(27.9)	8.4(27.6)	10.1(33.3)	13.3(43.9)
300"	-	8.2(26.8)	10.2(33.6)	10.1(33.3)	12.2(39.9)	16.2(53.3)

PDG-DET100L Throw distance (Unit: m (ft)) Aspect Ratio 4:3

Part Number	LNS-W52	LNS-W51	LNS-W50	LNS-S50	LNS-T50	LNS-T51
	Fixed	Wide	Tele	Wide	Tele	Wide
50"	0.84(2.77)	1.3(4.2)	1.6(5.3)	1.6(5.3)	1.9(6.3)	2.3(7.7)
60"	1.03(3.36)	1.5(5.1)	2.0(6.4)	1.9(6.4)	2.3(7.7)	3.1(10.2)
70"	1.21(3.96)	1.8(6.0)	2.3(7.5)	2.3(7.5)	2.8(9.1)	3.7(12.3)
80"	1.39(4.56)	2.1(6.9)	2.6(8.5)	2.6(8.5)	3.2(10.4)	4.3(14.1)
100"	1.75(5.76)	2.6(8.7)	3.3(11.0)	3.3(11.0)	4.0(13.1)	5.0(16.5)
150"	2.67(8.75)	4.0(13.2)	5.0(16.5)	5.0(16.3)	6.0(19.7)	7.8(25.6)
200"	3.58(11.74)	5.4(17.8)	6.8(22.2)	6.7(22.1)	8.0(26.4)	10.7(35.0)
250"	-	6.8(22.1)	8.5(27.8)	8.4(27.5)	10.1(33.3)	13.3(43.9)
300"	-	8.1(26.6)	10.2(33.4)	10.1(33.0)	12.1(39.8)	16.2(53.3)

* Approximate projection distances are calculated based on lens specifications. Individual lenses may diverge from this figure by up to 5% due to slight variations in lens size and shape.

Specifications

Model name	PDG-DHT100L / PDG-DHT100WL	PDG-DET100L
Panel	0.95" HD DLP® chip x 1	0.95" SXGA+ DLP® chip x 1
No. of pixels	2,073,600 (1920 x 1080 dots)	1,470,000 (1400 x 1050 dots)
Projection lamp	330 W VIDI™ UHP x 2	330 W VIDI™ UHP x 2
Brightness (typical) *1	6,500 lm (with LNS-S50, "Dynamic" image, DynamicBlack™ Off)	7,500 lm (with LNS-S50, "Dynamic" image, DynamicBlack™ Off)
Contrast *1	7,500:1 (with DynamicBlack™ High)	7,500:1 (with DynamicBlack™ High)
Uniformity *1	90% (corner to center)	90% (corner to center)
Image setting	Lens shift Vertical : 6.65:-1 --1:6.65 Horizontal : 10.7:1 - 1:10.7 Digital Keystone :U/D/R/L	Lens shift Vertical : 21:-1 --1:21 Horizontal : 19:1 - 1:19 Digital Keystone :U/D/R/L
Optional lens	LNS-W52/ W51/ W50/ S50/ T50/ T51 (Throw ratio: 0.8, 1.2 - 8.0)	LNS-W52/ W51/ W50/ S50/ T50/ T51 (Throw ratio: 0.87, 1.30 - 8.63)
Color wheels	Standard: 4seg RGBW for high brightness x 2 Standard accessory: 6seg RGBCMY for rich color reproduction x 2	Standard: 4seg RGBW for high brightness x 2 Standard accessory: 6seg RGBCMY for rich color reproduction x 2
Other Features	-Picture in Picture & Picture by Picture -Mechanical lens shutter -DynamicBlack™ (auto iris according to image) -BrilliantColor™ -VIDI™ UHP lamp variable illumination -Full 10 bit circuit -Auto picture control -Color management	-DICOM simulation -Picture in Picture & Picture by Picture -Mechanical lens shutter -DynamicBlack™ (auto iris according to image) -BrilliantColor™ -VIDI™ UHP lamp variable illumination -Full 10 bit circuit -Auto picture control -Color management
Signal Terminal	Input 1: RGB (D-sub15), DVI-D (HD/DCP), HDMI (v1.3 with Deep Color) Input 2: RGBHV, Y, Pb/Cb, Pr/Cr, Video (BNC), S-Video Input 3: Detachable terminal for system up Input 4: Detachable terminal (NETWORK POA-MD13NET2) Output: RGB (D-sub15)-Analog input only *HD DATA WIRELESS set is standard accessory in DHT100WL series	Input 1: RGB (D-sub15), DVI-D (HD/DCP), HDMI (v1.3 with Deep Color) Input 2: RGBHV, Y, Pb/Cb, Pr/Cr, Video (BNC), S-Video Input 3: Detachable terminal for system up Input 4: Detachable terminal (NETWORK POA-MD13NET2) Output: RGB (D-sub15)-Analog input only
Optional Terminal	Dual-SDI, DVI, 5BNC, D-sub15	Warp & Blending, Dual-SDI, DVI, 5BNC, D-sub15
Control Port	RJ-45 wired LAN (POA-MD13NET2), D-sub9pin (RS232C) In/Out, Wired R/C (Option: 30 m long cable compatible)	RJ-45 wired LAN (POA-MD13NET2), D-sub9pin (RS232C) In/Out, Wired R/C (Option: 30m long cable compatible)
Input signal compatibility	WUXGA/ UXGA/ WSXGA+ / SXGA+ / SXGA/ WXGA/ XGA/ SVGA/ VGA/ MAC, 1080p - 24/ 25/ 30/ 48/ 50/ 60, 1080psf - 24/ 25/ 30, 1080i - 50/ 60/ 720p - 50/ 60/ 575p/ 480p/ 575i/ 480i (depend on input)	WUXGA/ UXGA/ WSXGA+ / SXGA+ / SXGA/ WXGA/ XGA/ SVGA/ VGA/ MAC, 1080p - 24/ 25/ 30/ 48/ 50/ 60, 1080psf - 24/ 25/ 30, 1080i - 50/ 60, 720p - 50/ 60/ 575p/ 480p/ 575i/ 480i (depend on input)
Color systems	PAL / SECAM / NTSC / NTSC4.43 / PAL-M/N	PAL / SECAM / NTSC / NTSC4.43 / PAL-M/N
Scanning frequency	H sync 15 - 120 kHz/ V sync 48 - 120Hz/ Dot clock 230 MHz	H sync 15 - 120 kHz/ V sync 48 - 120 Hz/ Dot clock 230 MHz
Fan Noise	36 dB (Eco1)	36dB (Eco1)
Voltage	100 - 120 V/ 200 - 240 V AC (auto voltage)	100 - 120 V/ 200 - 240 V AC (auto voltage)
Dimensions (W x H x D)	400.0 x 242.5 x 523.5 mm (15.8 x 9.6 x 20.6")	400.0 x 242.5 x 523.5 mm (15.8 x 9.6 x 20.6")
Weight	19.8 kg (43.7 lbs) (without lens)	19.8 kg (43.7 lbs) (without lens)
Power Consumption	100-120 V 200-240 V PDG-DHT100WL: 860 W (Lamp Normal) / 29.0 W (Standby Eco1) PDG-DHT100L: 846 W (Lamp Normal) / 28.5 W (Standby Eco1) PDG-DHT100WL: 811 W (Lamp Normal) / 28.3 W (Standby Eco1) PDG-DHT100L: 794 W (Lamp Normal) / 27.8 W (Standby Eco1)	848 W (Lamp Normal) / 27.0 W (Standby Eco1) 805 W (Lamp Normal) / 26.5 W (Standby Eco1)
Main Accessories	HD DATA WIRELESS transmitter box x 1 (POA-HDTM01-PDG-DHT100WL only), HD DATA WIRELESS receiver board x 1 (POA-MD26HDWL-PDG-DHT100WL only), Rich color reproduction color wheel x 2 (High Brightness color wheel x 2 are installed in projector at shipping), Wireless/Wired remote unit x 1, "AA" type Batteries x 2, Owner's Manual (Quick Manual & CD-ROM), Real Color Manager Pro, CD-ROM x1, Computer Cable (Dsub15-Dsub15) x 1, AC Power Cord x 1, Cable cover set (support cover x 1, cover x 1, strap x 2), Cable tie for fixed cable x 3, Ferrite core (for LAN cable) x 1, PIN code label x 1	Rich color reproduction color wheel x 2 (High Brightness color wheel x 2 are installed in projector at shipping), Wireless/Wired remote unit x 1, "AA" type Batteries x 2, Owner's Manual (Quick Manual & CD-ROM), Real Color Manager Pro, CD-ROM x1, Computer Cable (Dsub15-Dsub15) x 1, AC Power Cord x 1, Cable cover set (support cover x 1, cover x 1, strap x 2), Cable tie for fixed cable x 3, Ferrite core (for LAN cable) x 1, PIN code label x 1

*1 Measurement, measuring conditions, and method of notation all comply with ISO 21118 international standards. * Replacement lamp type POA-LMP130 * "DLP" and "DynamicBlack" are registered trademarks of Texas Instruments.
* All product names and company names are trademarks or registered trademarks of their respective. * Design of the products, specifications are subject to change without notice.

DNV 813 ISO9001 REGISTERED FIRM
All products manufactured by the Projector Division of SANYO's Digital System Company employ a quality management system that has undergone the inspection and registration process of the ISO 9001 international standard.

JAB RE 009
ISO 14001 JAC
UKAS ENVIRONMENTAL MANAGEMENT 051
SANYO's Digital System Company has received ISO 14001 certification for the environmental management system used in its factory.

<http://www.sanyo-lcdp.com/>

Caution: Please consult the instruction manual to ensure safe and proper operation of the product.

Distributed by:



SANYO Electric Co., Ltd.
Digital System company

© 2009 SANYO Printed in Japan 2009.6 St.
SML136

Option Board

DVI / D-sub module	POA-MD23ADI
5BNC / VIDEO module	POA-MD25VD3
DVI module	POA-MD18DVI
5BNC module	POA-MD16VD1
Network module	POA-MD13NET2 (After Ver.4,404)
HD & SD-SDI module (SD-SDI not compatible)	POA-MD17SDID
HD DATA WIRELESS receiver board	POA-MD26HDWL (for PDG-DHT100L)
D-sub15 module	POA-MD04VGA
Warp & Blending	POA-MD21WARP (for PDG-DET100L)

Terminals

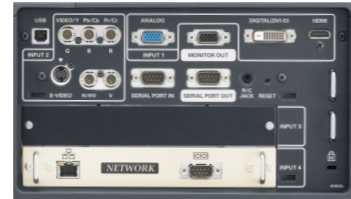

Transmitter



External dimensions (unit: mm (inch))

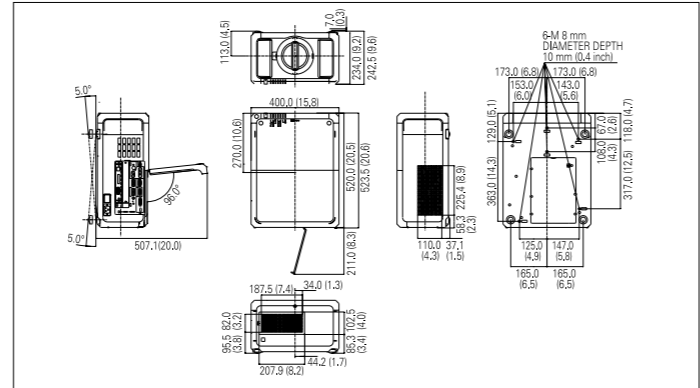

Think GAIA
For Life and the Earth



Multimedia Projector

PDG-DHT100L
PDG-DHT100WL
PDG-DET100L

Powerful Images for Large Venues and Digital Signage
The Industry's Brightest*



*PDG-DHT100L/ DHT100WL: As of June 30 2009, for 2-lamp, Full HD, 1-chip DLP® projector.
*PDG-DET100L: As of June 30 2009, for 2-lamp, SXGA+, 1-chip DLP® projectors.



Higher Brightness and Superior Images

High Resolution

The PDG-DHT100L/ DHT100WL/ DET100L built-in DLP® panel offer high contrast images. The PDG-DHT100L/ DHT100WL incorporate Full HD (1920 x 1080) panel to make Hi-vision content beautiful. The PDG-DET100L with SXGA+ (1400 x 1050) panel which is used to highly detailed images, such as design or CAD drawings makes a brilliant image.



Industry's Brightest*1 7,500 Lumens and Rich Color Reproduction (PDG-DET100L)

A twin color wheel system makes it possible to achieve both high brightness and high color reproduction that is accurate to image signal. In addition, the user can change color wheel to fit the application. The 4-segment color wheels team up with two high-output 330-watt lamps to achieve up to 7,500 Lumens*1 of brightness in our 2-lamp, SXGA+, 1-chip DLP® projector. Or you can choose the 6-segment color wheels for even richer, purer color reproduction. Built in Brilliant Color technology, with its rich color reproduction, makes images more brilliant. In addition, VIDI lighting technology controls the lamp power for each color wheel segment to maintain stable, high brightness, and significantly improve color performance.

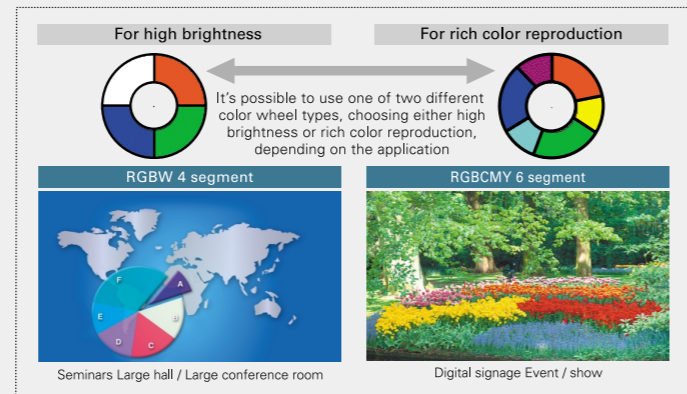
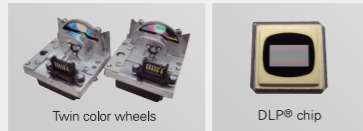

DICOM Simulation Mode*2 (PDG-DET100L)

Capable of projecting images approximated to DICOM Part 14 (grayscale standard display function) via 'DICOM Simulation Mode'*2, one of the display settings, a format standard for digital imaging and communications in medicine. - Projects X-ray pictures clearly and precisely; making it ideal for use in medical education.

*2 DICOM (Digital Imaging and Communications in Medicine) is an international standard for digital imaging and communications in medicine. This product is not a device for medical diagnosis. Do not use this product for actual medical diagnosis.

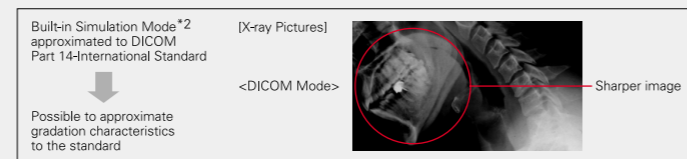

Note: The above is an image only for explanation

High Contrast 7500:1*3

This advanced optical system achieves high contrast*3 to project high-quality images with rich black reproduction, maximizing the quality of the video signals.

*3 with DynamicBlack™ High

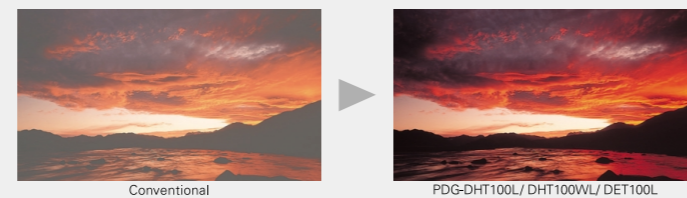

Network Control

HD*4 DATA WIRELESS (PDG-DHT100WL)

The Uncompressed HD*4 DATA WIRELESS Transmission System allows pure uncompressed data transmission without delays between the video and sound. Technology in wireless system allows uncompressed data even from distances of up to 30 meters*5 away from the input source. Easier set-up for place such as large event halls and other large rooms/theaters as it eliminates the need to feed cables and run wires from sources to projectors.

HD Wireless Transmission System is an enclosed accessory of PDG-DHT100WL and also is sold as optional accessory for PDG-DHT100L.

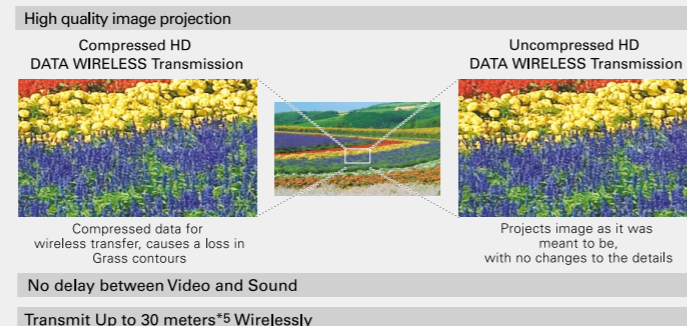

*4 HD stands for high definition of 1080i or 720p *5 Actual Distance is dependent on a variety of environmental conditions

Featuring the PJ-Net Organizer Board

The PJ-Net Organizer board is provided as standard equipment, for centralized control of projectors over a wired network. Installing the optional PJ Master into a PC or server also lets you control the PJ-Net Organizer-mounted projectors over a network.

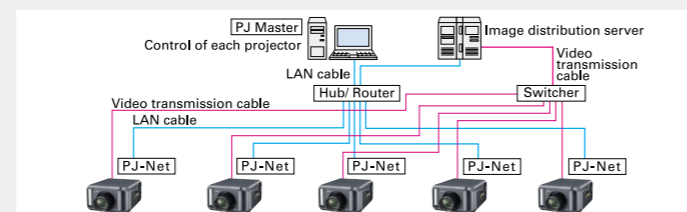

Easy Maintenance

The Industry's longest-lasting*6 35,000 hour-use filter 'Active Maintenance Filter', for cleaner and highly durable projection

Equipped with replaceable 'Active Maintenance Filter' for the Industry's longest lasting*6 35,000 hour-use automatic reel filter cartridge to prevent dust from entering the lamp area, while still allowing enough airflow to help the area to remain cool, causing longer durability and reliability on the increased dust resistance and longer lasting filters.

*6 As of the time of sales at the end of March, 2009 (when in Eco1 mode, Based on JIS D-0207 accelerated testing environment conditions) *25,000 hour-use (when in Normal mode, Based on JIS D-0207 accelerated testing environment conditions)

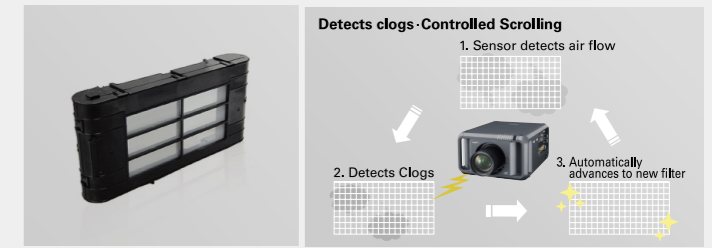

Equipped with new, dust-resistant sealed optical engine

New, improved sealed optical engine cooling design to prevent dust build up, maintaining optimal brightness and contrast, problems that traditionally are difficult to overcome, causing reductions in projection quality. Improved air control for more exibility in using the projector in a variety of environments.

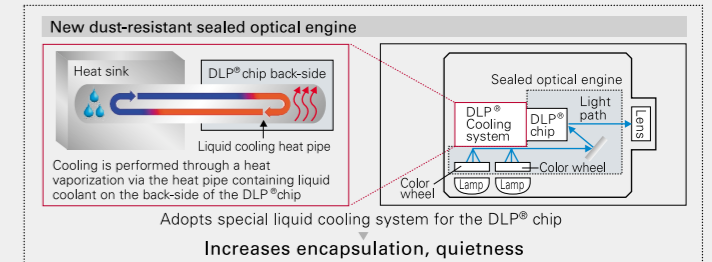

One-way Flow System

The PDG-DHT100L/ DHT100WL/ DET100L are concentrated into one intake and one exhaust, both on the side, to solve dust-related problems and improve cooling reliability.

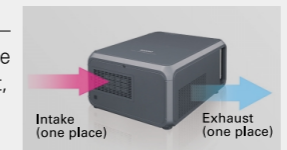

Easier Replacement

Lamp and Twin Color Wheel replacement has been simplified to make maintenance easier. Easy removal and replacement of the lamp from the top.



Versatile Installation

Edge Blending & Color Matching

Equipped with "Edge Blending" function that allows what feels like boundary-less images with multi-image display possibilities. Built-in "Color Matching" function correcting variations in color reproduction when using more than one projector.

'Edge Blending' function allows what feels like boundary-less images with multi-image display possibilities

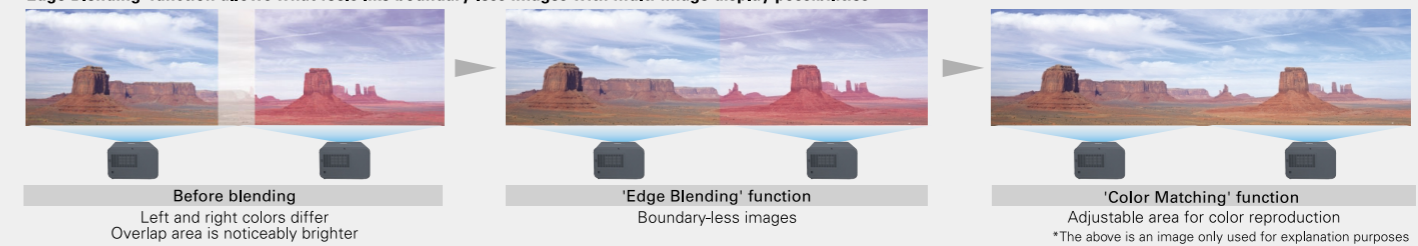

Power Lens Shift

Featuring both vertical and horizontal lens shift (PDG-DHT100L/ DHT100WL: vertical: 67 %, horizontal: 41 %, PDG-DET100L: vertical: 55 %, horizontal: 45 % (maximum)), the PDG-DHT100L/ DHT100WL/ DET100L enables intuitive operation for easy on-site setup. The lens shifts back to the center by pressing a lens shift button for 5 seconds.

Vertical Intration

Realizes vertical 360 degree tilt angle projection allowing projection positions from the ceiling or floor, breaking from traditional projection settings.

Interchangeable Lenses

Lens removal and attachment are also very easy.

Picture in Picture mode and Picture by Picture mode

Capable of projecting two images simultaneously either using built-in picture in picture mode or picture by picture mode.

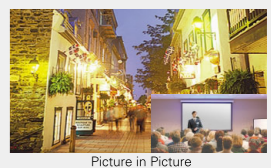

Useful Features

- Direct off Function: The projector can be turned off by unplugging the cable without pressing the power button. You can pack up and leave quickly.
- There is also a Mechanical Shutter System which is popular for a variety of elite professional uses. The amazing PDG-DHT100L/ DHT100WL/ DET100L fill the needs of a host of demanding business venues including meeting, entertainment and promotional applications. It's a super nova in a star-studded selection of SANYO Portable projectors.
- "Lens center layout" symmetrical design
- Full light-up Control Panel & Terminal & Remote Control

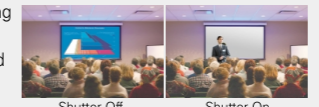

6,500 Im Full HD Projector
PDG-DHT100L/ PDG-DHT100WL

7,500 Im SXGA+ Projector
PDG-DET100L